

Features

- 20V/12A,
 $R_{DS(ON)} = 7.5m\Omega(Typ.)@V_{GS}=10V$
 $R_{DS(ON)} = 8m\Omega(Typ.)@V_{GS}=4.5V$
 $R_{DS(ON)} = 10m\Omega(Typ.)@V_{GS}=2.5V$
- Low $R_{DS(ON)}$
- Super High Dense Cell Design
- Reliable and Rugged

Applications

- Power Management
- Battery Protection



Halogen-Free

Pin Description

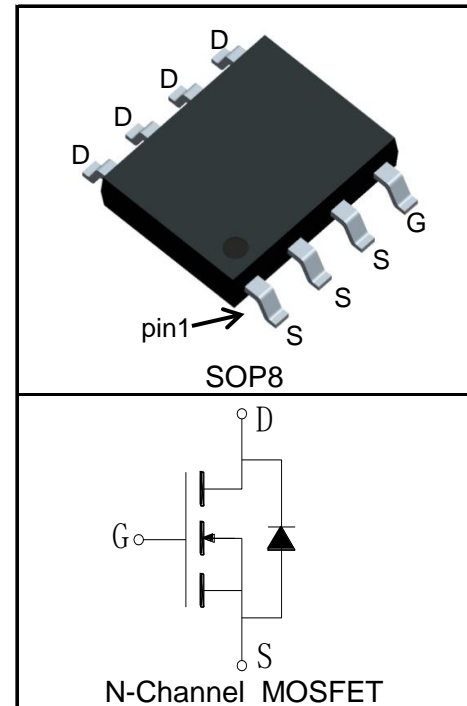

Absolute Maximum Ratings

| Symbol | Parameter | Rating | Unit | |
|--|--|------------------------|--------------------|---|
| Common Ratings ($T_A=25^\circ\text{C}$ Unless Otherwise Noted) | | | | |
| V_{DSS} | Drain-Source Voltage | 20 | V | |
| V_{GSS} | Gate-Source Voltage | ± 12 | | |
| T_J | Maximum Junction Temperature | 150 | $^\circ\text{C}$ | |
| T_{STG} | Storage Temperature Range | -55 to 150 | $^\circ\text{C}$ | |
| I_S | Diode Continuous Forward Current | $T_A=25^\circ\text{C}$ | 2.9 | A |
| Mounted on Large Heat Sink | | | | |
| $I_{DP}^{①}$ | 300 μs Pulse Drain Current Tested | $T_A=25^\circ\text{C}$ | 48 | A |
| $I_D^{②}$ | Continuous Drain Current($V_{GS}=4.5V$) | $T_A=25^\circ\text{C}$ | 12 | A |
| | | $T_A=70^\circ\text{C}$ | 9.6 | |
| P_D | Maximum Power Dissipation | $T_A=25^\circ\text{C}$ | 2.5 | W |
| | | $T_A=70^\circ\text{C}$ | 1.6 | |
| $R_{\theta JC}$ | Thermal Resistance-Junction to Case | - | $^\circ\text{C/W}$ | |
| $R_{\theta JA}^{③}$ | Thermal Resistance-Junction to Ambient | 50 | $^\circ\text{C/W}$ | |
| Drain-Source Avalanche Ratings | | | | |
| $E_{AS}^{④}$ | Avalanche Energy, Single Pulsed | 45 | mJ | |

Electrical Characteristics ($T_A=25^\circ\text{C}$ Unless Otherwise Noted)

| Symbol | Parameter | Test Condition | KS2222HB | | | Unit |
|--|----------------------------------|--|----------|------|-----------|-----------|
| | | | Min. | Typ. | Max. | |
| Static Characteristics | | | | | | |
| BV_{DSS} | Drain-Source Breakdown Voltage | $V_{GS}=0V, I_{DS}=250\mu A$ | 20 | | | V |
| I_{DSS} | Zero Gate Voltage Drain Current | $V_{DS}=20V, V_{GS}=0V$ | | | 1 | μA |
| | | $T_J=125^\circ\text{C}$ | | | 30 | |
| $V_{GS(th)}$ | Gate Threshold Voltage | $V_{DS}=V_{GS}, I_{DS}=250\mu A$ | 0.4 | 0.7 | 1 | V |
| I_{GSS} | Gate Leakage Current | $V_{GS}=\pm 12V, V_{DS}=0V$ | | | ± 100 | nA |
| $R_{DS(ON)}^{(5)}$ | Drain-Source On-state Resistance | $V_{GS}=10V, I_{DS}=10A$ | | 7.5 | 9 | $m\Omega$ |
| | | $V_{GS}=4.5V, I_{DS}=8A$ | | 8 | 11 | $m\Omega$ |
| | | $V_{GS}=2.5V, I_{DS}=4A$ | | 10 | 15 | $m\Omega$ |
| Diode Characteristics | | | | | | |
| $V_{SD}^{(5)}$ | Diode Forward Voltage | $I_{SD}=10A, V_{GS}=0V$ | | 0.85 | 1.2 | V |
| t_{rr} | Reverse Recovery Time | $I_{SD}=10A, dI_{SD}/dt=100A/\mu s$ | | 10 | | ns |
| Q_{rr} | Reverse Recovery Charge | | | 21 | | nC |
| Dynamic Characteristics⁽⁶⁾ | | | | | | |
| R_G | Gate Resistance | $V_{GS}=0V, V_{DS}=0V, F=1\text{MHz}$ | | 2.3 | | Ω |
| C_{iss} | Input Capacitance | $V_{GS}=0V,$ $V_{DS}=10V,$ Frequency=1.0MHz | | 1250 | | pF |
| C_{oss} | Output Capacitance | | | 215 | | |
| C_{riss} | Reverse Transfer Capacitance | | | 170 | | |
| $t_{d(ON)}$ | Turn-on Delay Time | $V_{DD}=10V, I_{DS}=10A,$ $V_{GEN}=4.5V, R_G=3\Omega$ | | 3 | | ns |
| t_r | Turn-on Rise Time | | | 6 | | |
| $t_{d(OFF)}$ | Turn-off Delay Time | | | 11 | | |
| t_f | Turn-off Fall Time | | | 8 | | |
| Gate Charge Characteristics⁽⁶⁾ | | | | | | |
| Q_g | Total Gate Charge | $V_{DS}=10V, V_{GS}=4.5V,$ $I_{DS}=10A$ | | 16 | | nC |
| Q_{gs} | Gate-Source Charge | | | 7 | | |
| Q_{gd} | Gate-Drain Charge | | | 6 | | |

- Notes:
- ① Pulse width limited by safe operating area.
 - ② Calculated continuous current based on maximum allowable junction temperature.
 - ③ When mounted on 1 inch square copper board, $t \leq 10\text{sec}$. The value in any given application depends on the user's specific board design.
 - ④ Limited by T_{Jmax} , starting $T_J = 25^\circ\text{C}$, $L = 0.1\text{mH}$, $R_G = 25\Omega$, $I_{AS} = 30A$, $V_{GS} = 10V$.
 - ⑤ Pulse test; Pulse width $\leq 300\mu s$, duty cycle $\leq 2\%$.
 - ⑥ Guaranteed by design, not subject to production testing.

Ordering and Marking Information

| Device | Package | Packaging | Quantity | Reel Size | Tape width |
|----------|---------|-----------|----------|-----------|------------|
| KS2222HB | SOP8 | Tape&Reel | 3000 | 13" | 12mm |

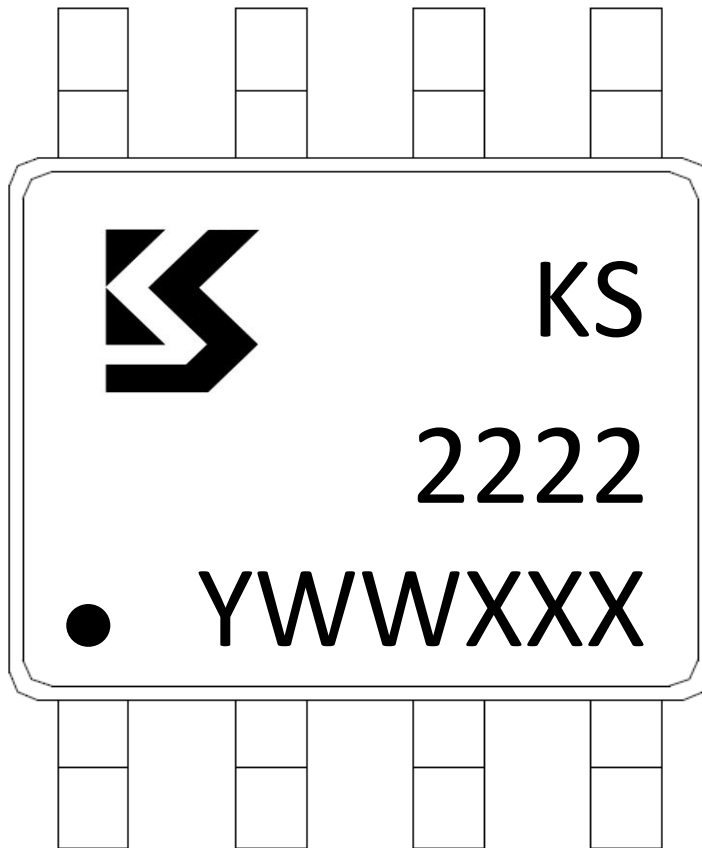

Y =Year,2017-A,2018-B,etc.
 WW =Week.
 XXX =Lot number.

Typical Characteristics

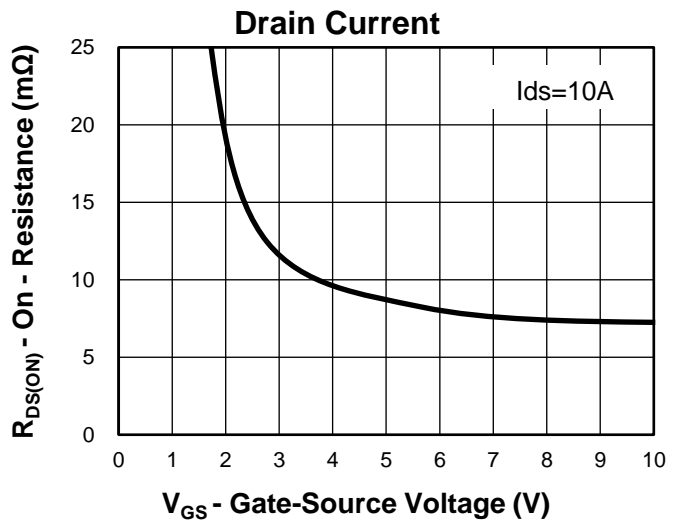
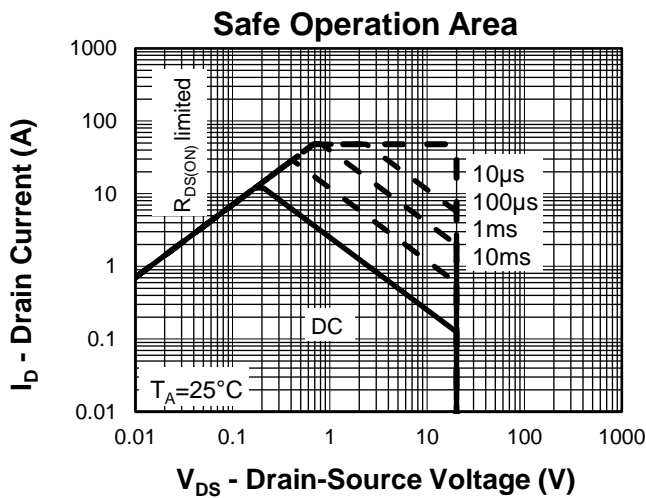
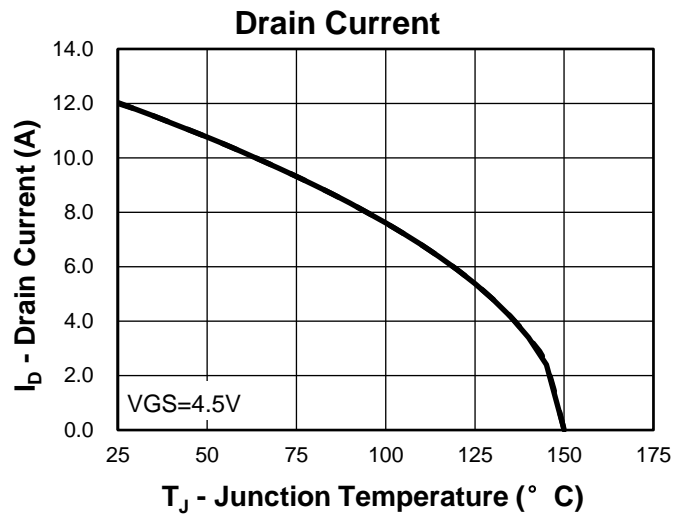
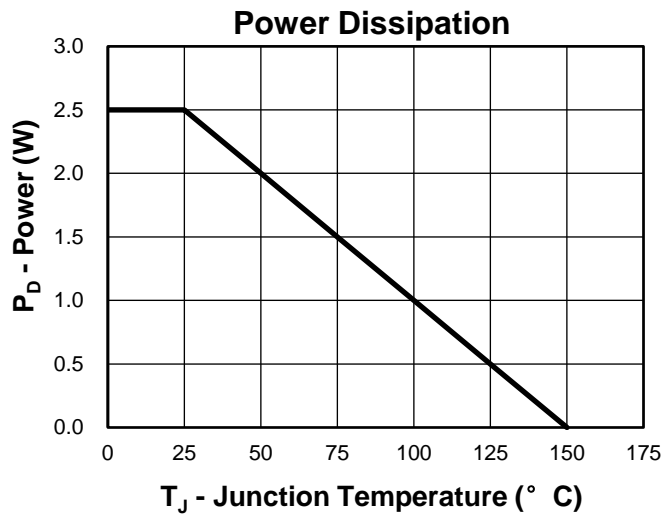

Thermal Transient Impedance

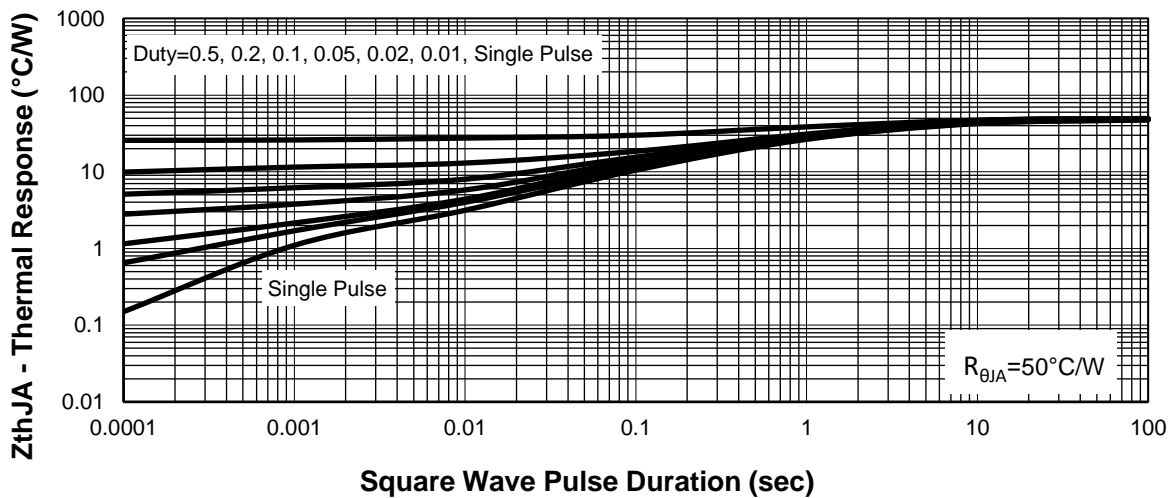

Typical Characteristics

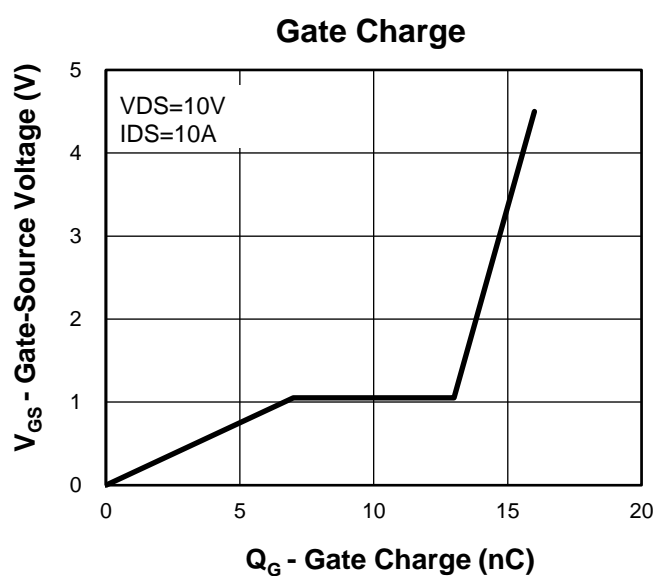
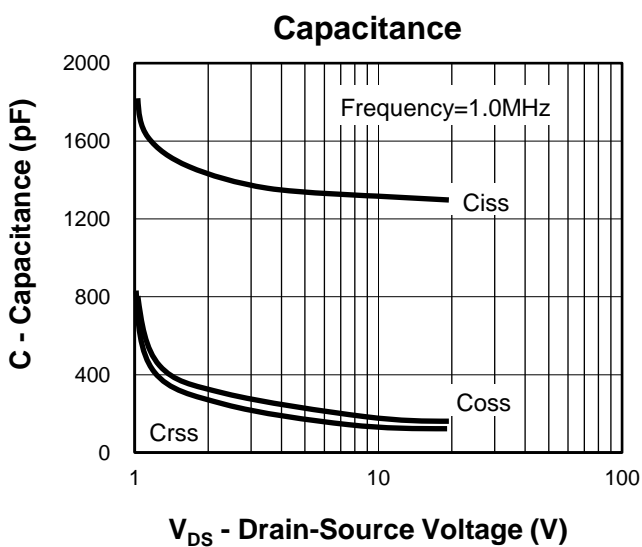
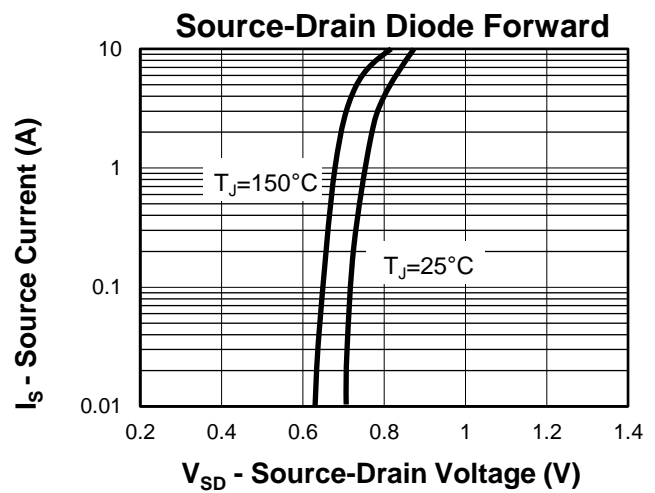
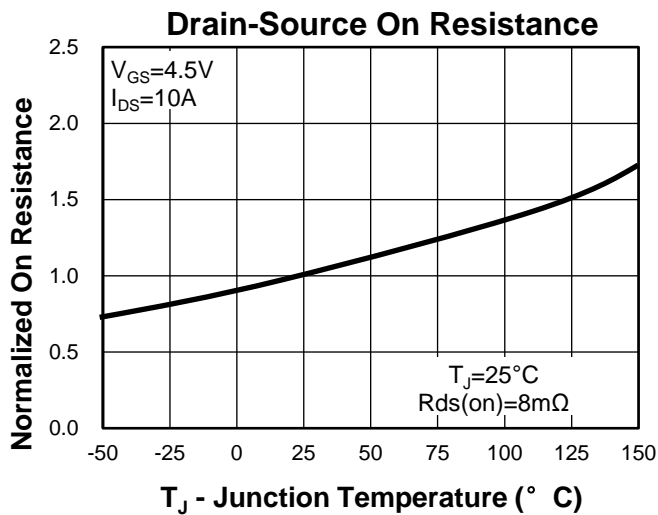
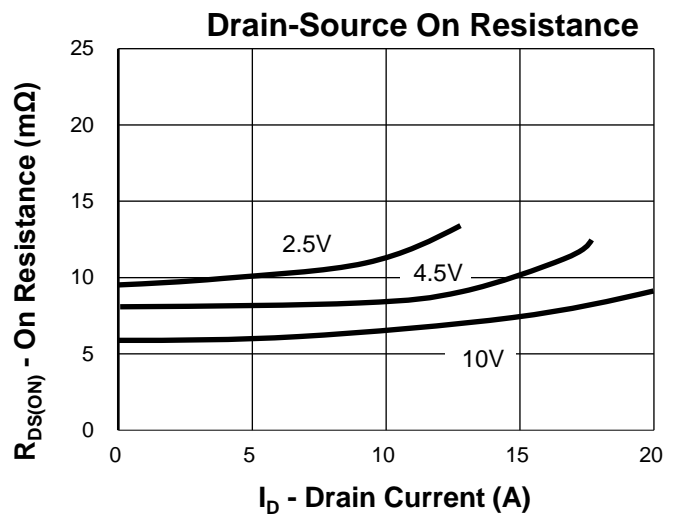
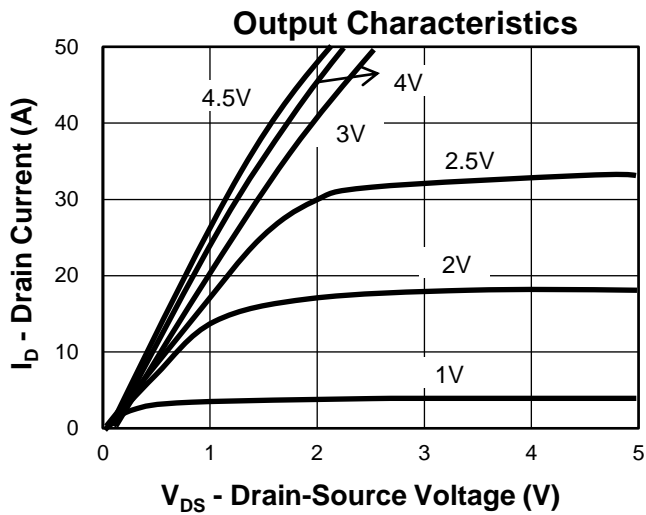

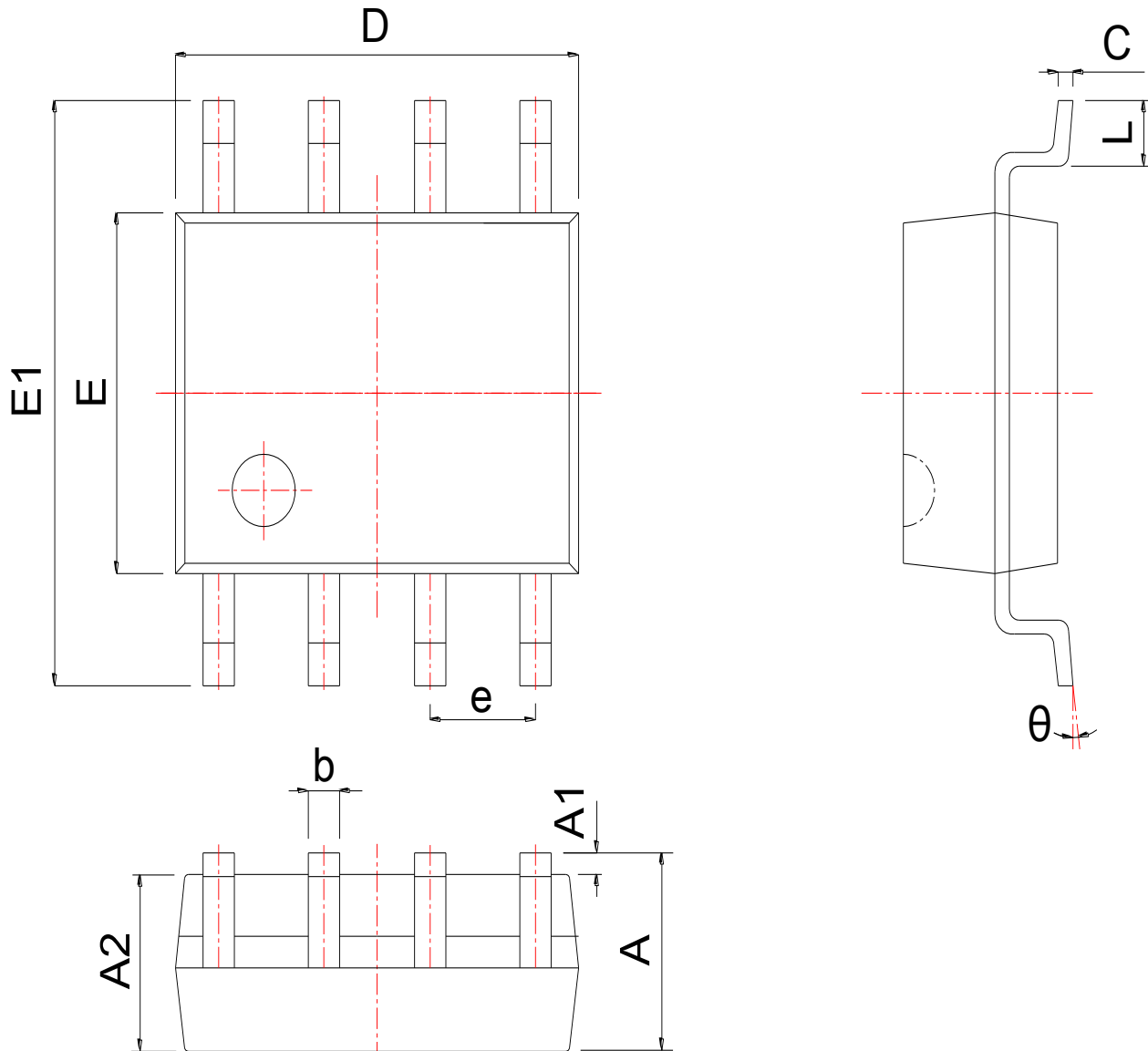
Package Information
SOP8

| SYMBOL | MM | | | INCH | | |
|--------|-----------|-------|-------|-----------|-------|-------|
| | MIN | NOM | MAX | MIN | NOM | MAX |
| A | 1.300 | 1.525 | 1.750 | 0.051 | 0.060 | 0.069 |
| A1 | 0.050 | 0.150 | 0.250 | 0.002 | 0.006 | 0.010 |
| A2 | 1.350 | 1.450 | 1.550 | 0.053 | 0.057 | 0.061 |
| b | 0.330 | 0.420 | 0.510 | 0.013 | 0.017 | 0.020 |
| c | 0.170 | 0.210 | 0.250 | 0.007 | 0.008 | 0.010 |
| D | 4.700 | 4.900 | 5.100 | 0.185 | 0.193 | 0.201 |
| E | 3.800 | 3.900 | 4.000 | 0.150 | 0.154 | 0.157 |
| E1 | 5.800 | 6.000 | 6.200 | 0.228 | 0.236 | 0.244 |
| e | 1.270 BSC | | | 0.050 BSC | | |
| L | 0.400 | 0.835 | 1.270 | 0.016 | 0.033 | 0.050 |
| θ | 0° | | 8° | 0° | | 8° |

Avalanche Test Circuit and Waveforms



Switching Time Test Circuit and Waveforms

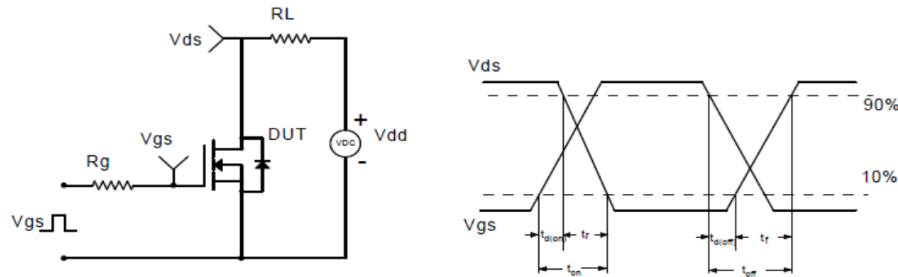

Diode Recovery Test Circuit and Waveforms

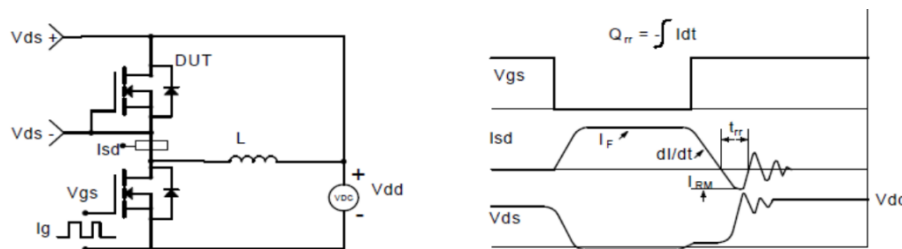

Gate Charge Test Circuit and Waveform

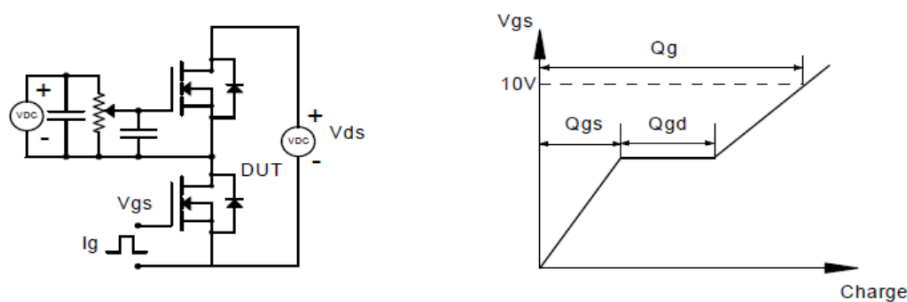

Customer Service

Kwansemi Semiconductor Co.,Ltd

Email:Sales@kwansemi.com

Web:www.kwansemi.com

DISCLAIMER:

Kwansemi reserves the right to change the specifications and circuitry without notice at any time. The Products are not designed for use in hostile environments, including, without limitation, aircraft, nuclear power generation, medical appliances, and devices or systems in which malfunction of any Product can reasonably be expected to result in a personal injury. Seller's customers using or selling Seller's products for use in such applications do so at their own risk and agree to fully defend and indemnify Seller.