

Features

- 40V/65A,
 $R_{DS(ON)} = 7m\Omega(Typ.)@V_{GS}=10V$
 $R_{DS(ON)} = 10m\Omega(Typ.)@V_{GS}=4.5V$
- Low $R_{DS(ON)}$
- Super High Dense Cell Design
- Reliable and Rugged

Applications

- Power Switching Application
- Load Switching



Halogen-Free

Pin Description

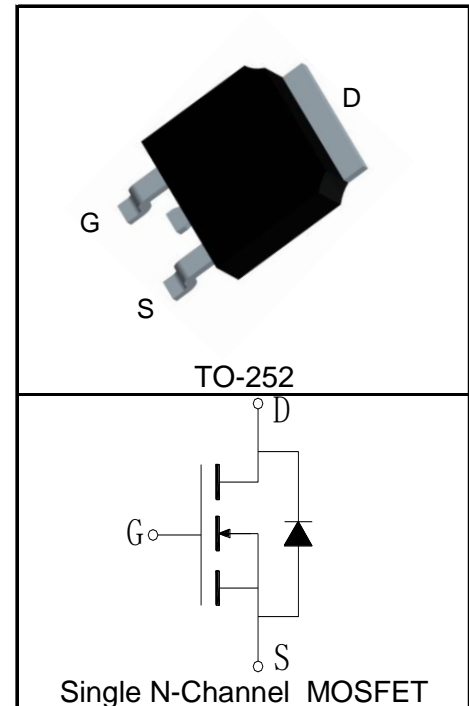

Absolute Maximum Ratings

Symbol	Parameter	Rating	Unit	
Common Ratings ($T_C=25^\circ\text{C}$ Unless Otherwise Noted)				
V_{DSS}	Drain-Source Voltage	40	V	
V_{GSS}	Gate-Source Voltage	± 20		
T_J	Maximum Junction Temperature	175	$^\circ\text{C}$	
T_{STG}	Storage Temperature Range	-55 to 175	$^\circ\text{C}$	
I_S	Diode Continuous Forward Current	$T_C=25^\circ\text{C}$	65	A
Mounted on Large Heat Sink				
$I_{DP}^{(1)}$	300 μs Pulse Drain Current Tested	$T_C=25^\circ\text{C}$	260	A
$I_D^{(2)}$	Continuous Drain Current($V_{GS}=10V$)	$T_C=25^\circ\text{C}$	65	A
		$T_C=100^\circ\text{C}$	45	
P_D	Maximum Power Dissipation	$T_C=25^\circ\text{C}$	53	W
		$T_C=100^\circ\text{C}$	26	
$R_{\theta JC}$	Thermal Resistance-Junction to Case		2.8	$^\circ\text{C/W}$
$R_{\theta JA}^{(3)}$	Thermal Resistance-Junction to Ambient		100	$^\circ\text{C/W}$
Drain-Source Avalanche Ratings				
$E_{AS}^{(4)}$	Avalanche Energy, Single Pulsed		196	mJ

Electrical Characteristics ($T_C=25^\circ\text{C}$ Unless Otherwise Noted)

Symbol	Parameter	Test Condition	KS4210DA			Unit
			Min.	Typ.	Max.	
Static Characteristics						
BV_{DSS}	Drain-Source Breakdown Voltage	$V_{GS}=0V, I_{DS}=250\mu A$	40			V
I_{DSS}	Zero Gate Voltage Drain Current	$V_{DS}=40V, V_{GS}=0V$			1	μA
		$T_J=125^\circ\text{C}$			30	
$V_{GS(th)}$	Gate Threshold Voltage	$V_{DS}=V_{GS}, I_{DS}=250\mu A$	1	1.5	2.5	V
I_{GSS}	Gate Leakage Current	$V_{GS}=\pm 20V, V_{DS}=0V$			± 100	nA
$R_{DS(ON)}^{(5)}$	Drain-Source On-state Resistance	$V_{GS}=10V, I_{DS}=20A$		7	9	$m\Omega$
		$V_{GS}=4.5V, I_{DS}=16A$		10	15	$m\Omega$
Diode Characteristics						
$V_{SD}^{(5)}$	Diode Forward Voltage	$I_{SD}=20A, V_{GS}=0V$		0.8	1.2	V
t_{rr}	Reverse Recovery Time	$I_{SD}=20A, dI_{SD}/dt=100A/\mu s$		13		ns
Q_{rr}	Reverse Recovery Charge			52		nC
Dynamic Characteristics⁽⁶⁾						
R_G	Gate Resistance	$V_{GS}=0V, V_{DS}=0V, F=1\text{MHz}$		1.5		Ω
C_{iss}	Input Capacitance	$V_{GS}=0V,$ $V_{DS}=20V,$ Frequency=1.0MHz		2080		pF
C_{oss}	Output Capacitance			160		
C_{rss}	Reverse Transfer Capacitance			130		
$t_{d(ON)}$	Turn-on Delay Time	$V_{DD}=20V, I_{DS}=20A,$ $V_{GEN}=10V, R_G=3\Omega$		13		ns
t_r	Turn-on Rise Time			37		
$t_{d(OFF)}$	Turn-off Delay Time			50		
t_f	Turn-off Fall Time			12		
Gate Charge Characteristics⁽⁶⁾						
Q_g	Total Gate Charge	$V_{DS}=20V, V_{GS}=10V,$ $I_{DS}=20A$		48		nC
Q_{gs}	Gate-Source Charge			6		
Q_{gd}	Gate-Drain Charge			13		

- Notes:
- ① Pulse width limited by safe operating area.
 - ② Calculated continuous current based on maximum allowable junction temperature. The package limitation current is 60A.
 - ③ When mounted on 1 inch square copper board, $t \leq 10\text{sec}$. The value in any given application depends on the user's specific board design.
 - ④ Limited by T_{Jmax} , $I_{AS} = 28A$, $L = 0.5\text{mH}$, $V_{DD} = 30V$, $R_G = 25\Omega$, Starting $T_J = 25^\circ\text{C}$.
 - ⑤ Pulse test; Pulse width $\leq 300\mu s$, duty cycle $\leq 2\%$.
 - ⑥ Guaranteed by design, not subject to production testing.

Ordering and Marking Information

Device	Package	Packaging	Quantity	Reel Size	Tape width
KS4210DA	TO-252	Tape&Reel	2500	13"	16mm

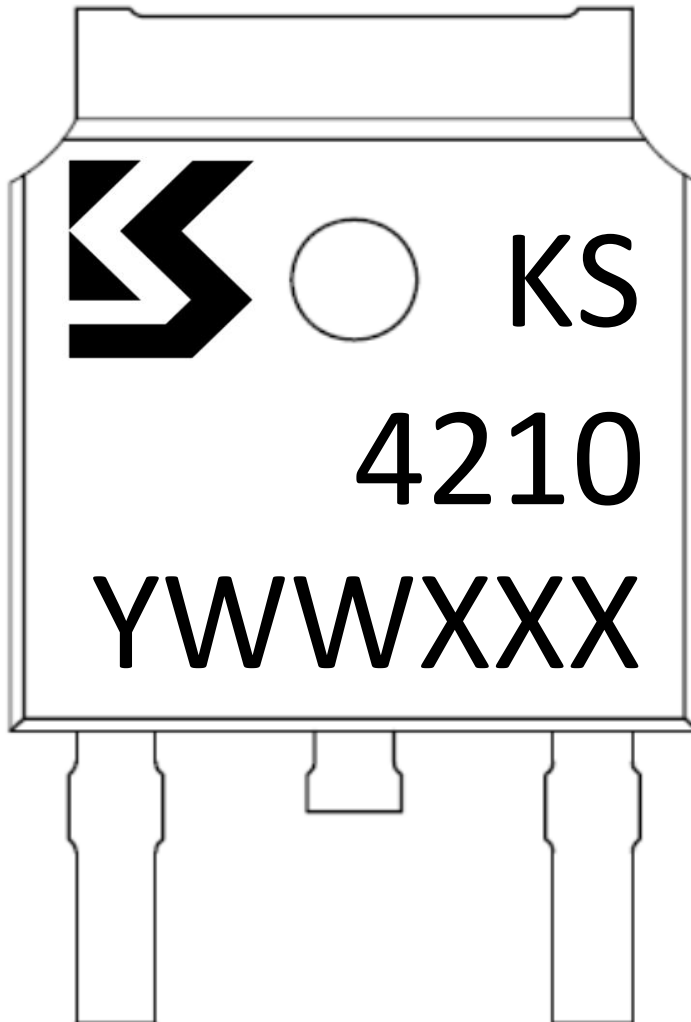

Y =Year,2017-A,2018-B,etc.

WW =Week.

XXX =Lot number.

Typical Characteristics

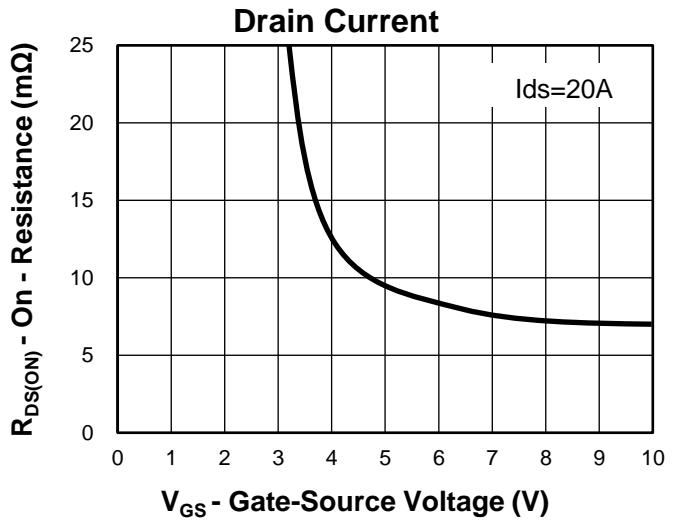
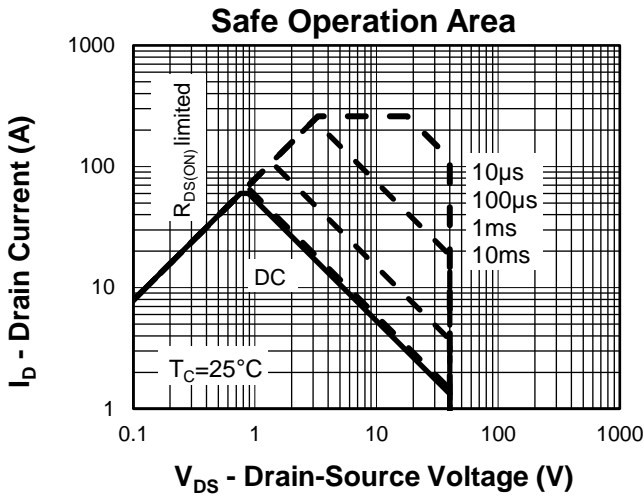
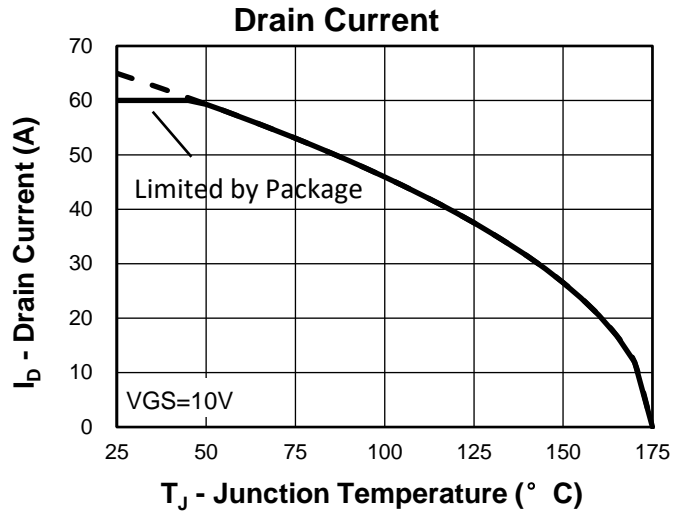
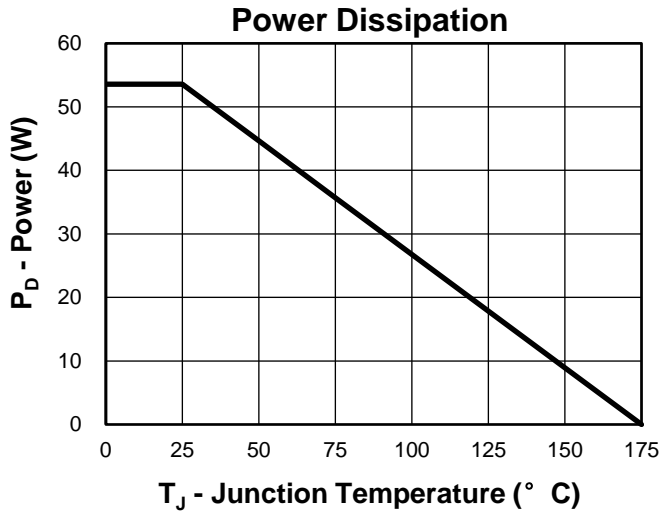

Thermal Transient Impedance

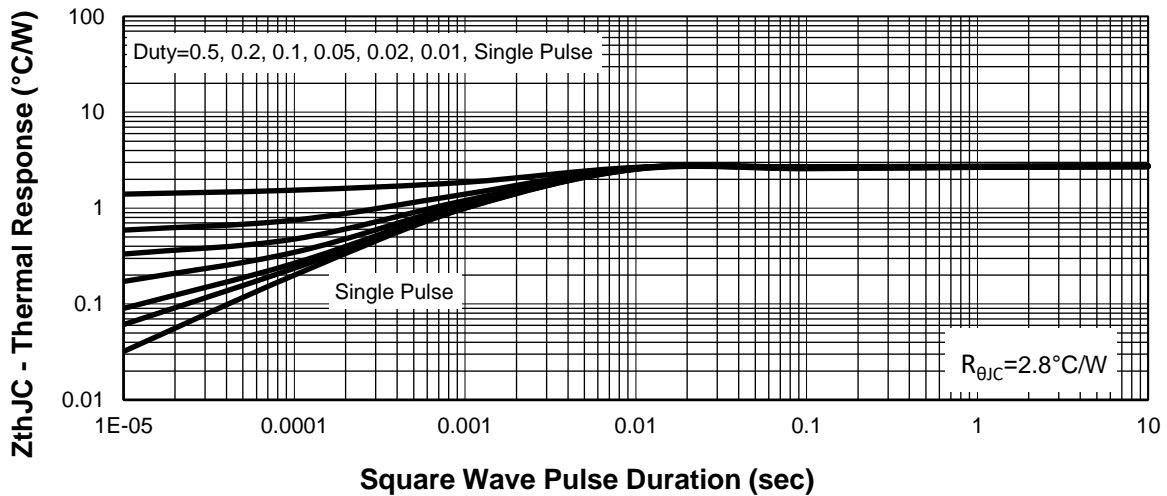

Typical Characteristics

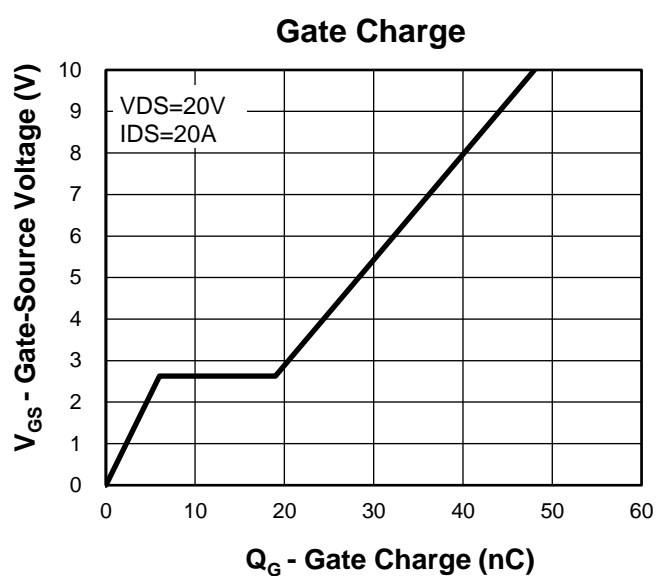
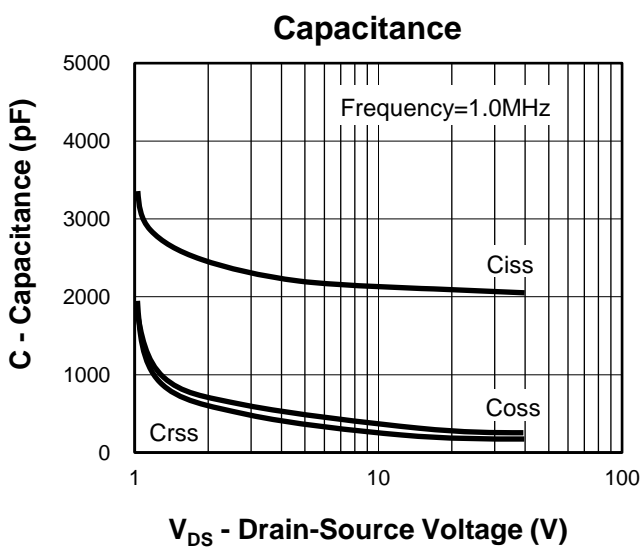
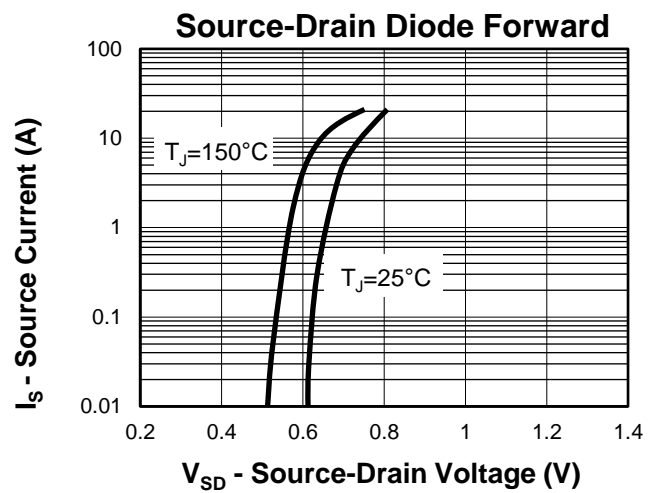
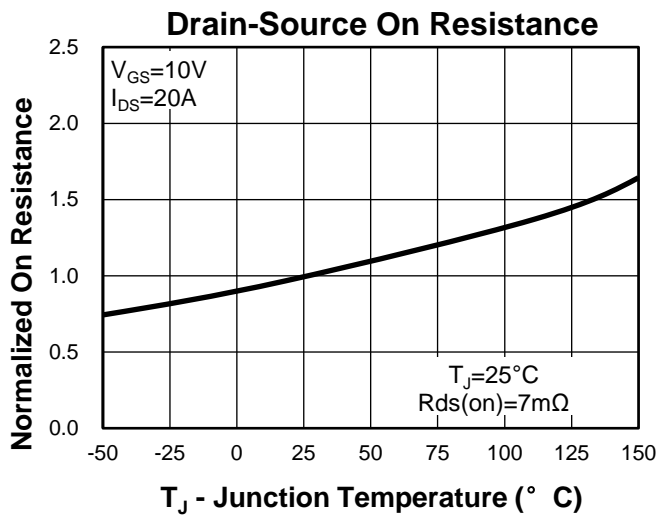
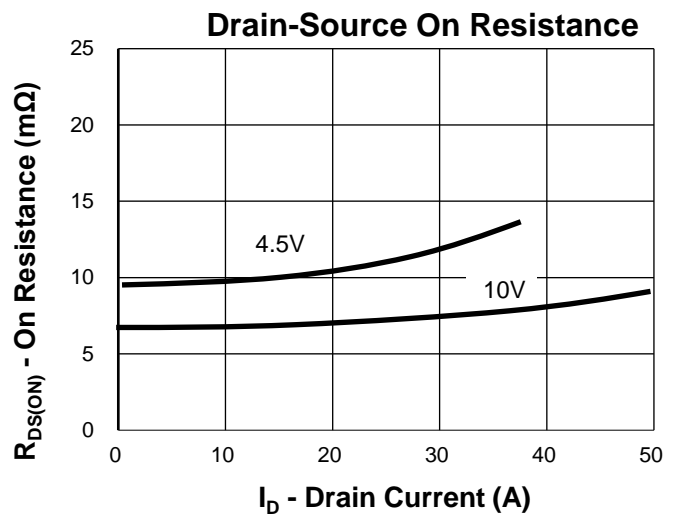
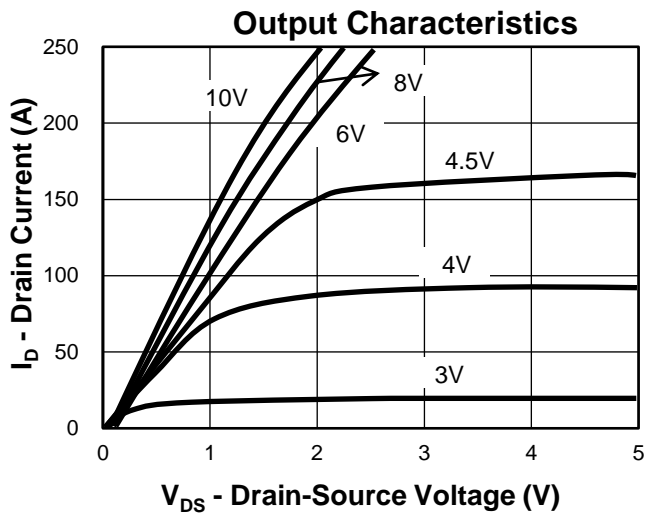

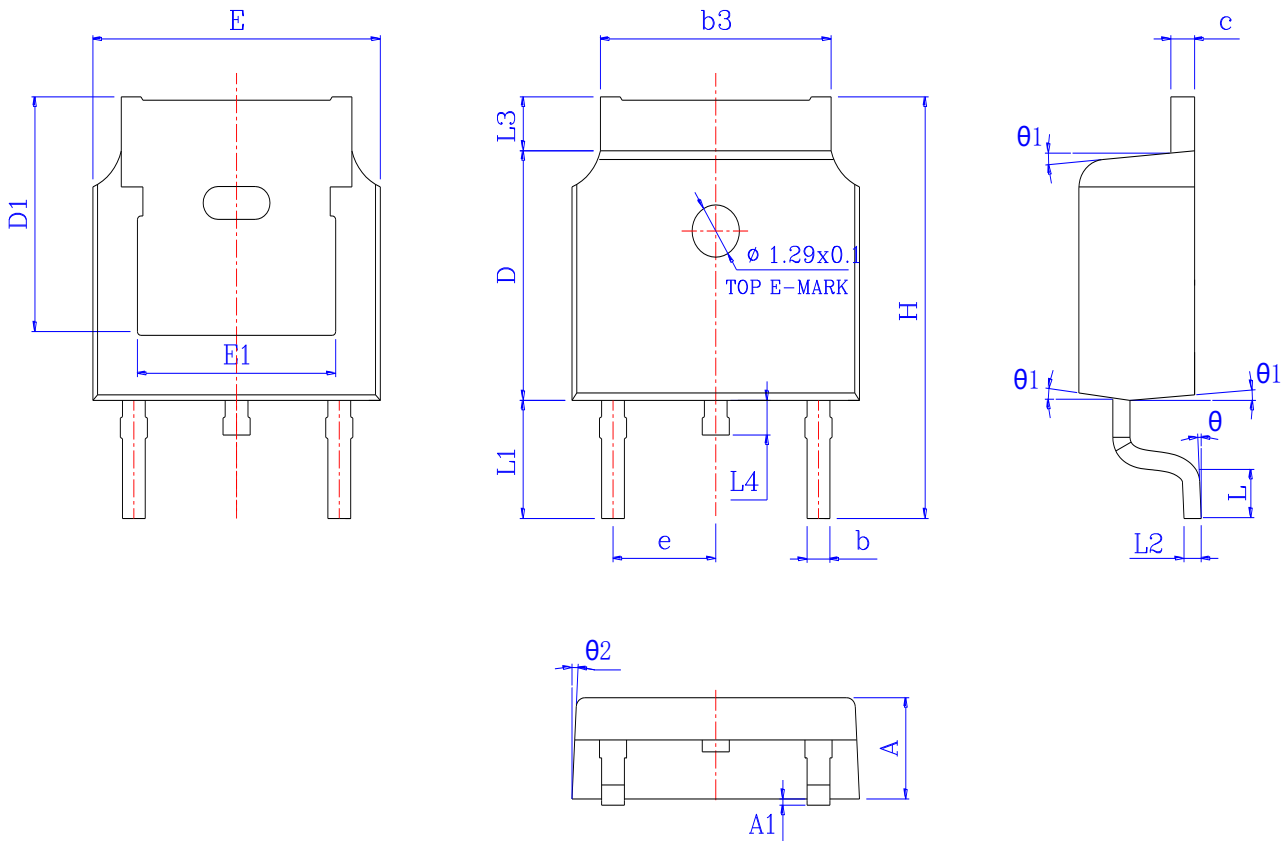
Package Information
TO-252

SYMBOL	MM			INCH		
	MIN	NOM	MAX	MIN	NOM	MAX
A	2.200	2.300	2.400	0.087	0.091	0.094
A1	*	*	0.100	*	*	0.004
b	0.660	0.760	0.860	0.026	0.030	0.034
b3	5.130	5.295	5.460	0.202	0.208	0.215
c	0.470	0.535	0.600	0.019	0.021	0.024
D	6.000	6.100	6.200	0.236	0.240	0.244
D1	5.30 REF			0.20 REF		
E	6.500	6.600	6.700	0.256	0.260	0.264
E1	4.700	*	*	0.185	*	*
e	2.28 REF			0.09 REF		
H	9.800	10.100	10.400	0.386	0.398	0.409
L	1.400	1.550	1.700	0.055	0.061	0.067
L1	2.743 REF			0.108 REF		
L2	0.510 BSC			0.020 BSC		
L3	0.900	1.075	1.250	0.035	0.042	0.049
L4	0.600	0.800	1.000	0.024	0.031	0.039
θ	0°	*	8°	0°	*	8°
$\theta 1$	5°	7°	9°	5°	7°	9°
$\theta 2$	5°	7°	9°	5°	7°	9°

Avalanche Test Circuit and Waveforms



Switching Time Test Circuit and Waveforms



Diode Recovery Test Circuit and Waveforms



Gate Charge Test Circuit and Waveform



Customer Service

Kwansemi Semiconductor Co.,Ltd

Email:Sales@kwansemi.com

Web:www.kwansemi.com

DISCLAIMER:

Kwansemi reserves the right to change the specifications and circuitry without notice at any time. The Products are not designed for use in hostile environments, including, without limitation, aircraft, nuclear power generation, medical appliances, and devices or systems in which malfunction of any Product can reasonably be expected to result in a personal injury. Seller's customers using or selling Seller's products for use in such applications do so at their own risk and agree to fully defend and indemnify Seller.