

## Features

- 100V/4A,  
 $R_{DS(ON)} = 110\text{m}\Omega(\text{Typ.})@V_{GS}=10\text{V}$   
 $R_{DS(ON)} = 140\text{m}\Omega(\text{Typ.})@V_{GS}=4.5\text{V}$
- Excellent  $Q_G \times R_{DS(on)}$  product(FOM)
- SGT Technology
- Low Capacitance to Minimize Driver Losses
- Fast Switching Speed

## Applications

- DC/DC Converter
- Load Switch



Halogen-Free

## Pin Description

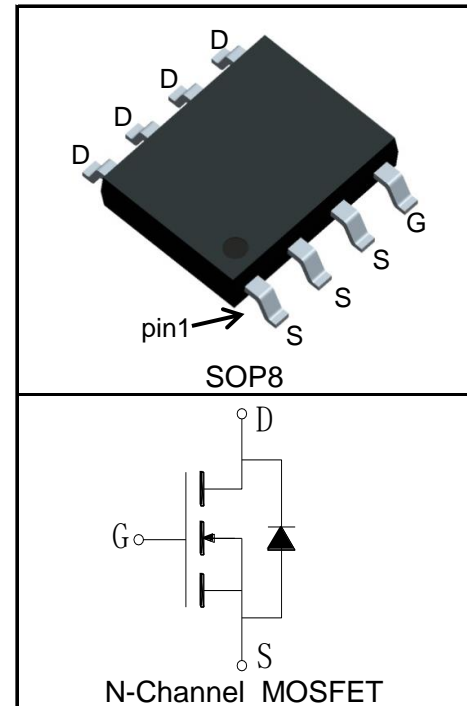

## Absolute Maximum Ratings

Symbol	Parameter	Rating	Unit
<b>Common Ratings</b> ( $T_A=25^\circ\text{C}$ Unless Otherwise Noted)			
$V_{DSS}$	Drain-Source Voltage	100	V
$V_{GSS}$	Gate-Source Voltage	$\pm 20$	
$T_J$	Maximum Junction Temperature	150	$^\circ\text{C}$
$T_{STG}$	Storage Temperature Range	-55 to 150	$^\circ\text{C}$
$I_S$	Diode Continuous Forward Current	$T_A=25^\circ\text{C}$ 2.7	A
<b>Mounted on Large Heat Sink</b>			
$I_{DP}^{①}$	300 $\mu\text{s}$ Pulse Drain Current Tested	$T_A=25^\circ\text{C}$ 16	A
$I_D^{②}$	Continuous Drain Current( $V_{GS}=10\text{V}$ )	$T_A=25^\circ\text{C}$ 4	A
		$T_A=70^\circ\text{C}$ 3.2	
$P_D$	Maximum Power Dissipation	$T_A=25^\circ\text{C}$ 2.5	W
		$T_A=70^\circ\text{C}$ 1.6	
$R_{\theta JL}$	Thermal Resistance-Junction to Lead	35	$^\circ\text{C}/\text{W}$
$R_{\theta JA}^{③}$	Thermal Resistance-Junction to Ambient	50	$^\circ\text{C}/\text{W}$
<b>Drain-Source Avalanche Ratings</b>			
$E_{AS}^{④}$	Avalanche Energy, Single Pulsed	TBD	mJ

**Electrical Characteristics** ( $T_A=25^\circ\text{C}$  Unless Otherwise Noted)

Symbol	Parameter	Test Condition	KS1260HAT			Unit
			Min.	Typ.	Max.	
<b>Static Characteristics</b>						
$BV_{DSS}$	Drain-Source Breakdown Voltage	$V_{GS}=0V, I_{DS}=250\mu A$	100			V
$I_{DSS}$	Zero Gate Voltage Drain Current	$V_{DS}=100V, V_{GS}=0V$			1	$\mu A$
		$T_J=125^\circ C$			30	
$V_{GS(th)}$	Gate Threshold Voltage	$V_{DS}=V_{GS}, I_{DS}=250\mu A$	1.2	1.6	2.3	V
$I_{GSS}$	Gate Leakage Current	$V_{GS}=\pm 20V, V_{DS}=0V$			$\pm 100$	nA
$R_{DS(ON)}^{(5)}$	Drain-Source On-state Resistance	$V_{GS}=10V, I_{DS}=3A$		110	140	$m\Omega$
		$V_{GS}=4.5V, I_{DS}=2A$		140	170	$m\Omega$
<b>Diode Characteristics</b>						
$V_{SD}^{(5)}$	Diode Forward Voltage	$I_{SD}=3A, V_{GS}=0V$		0.92	1.2	V
$t_{rr}$	Reverse Recovery Time	$I_{SD}=3A, di_{SD}/dt=100A/\mu s$		12		ns
$Q_{rr}$	Reverse Recovery Charge			20		nC
<b>Dynamic Characteristics<sup>(6)</sup></b>						
$R_G$	Gate Resistance	$V_{GS}=0V, V_{DS}=0V, F=1MHz$		0.9		$\Omega$
$C_{iss}$	Input Capacitance	$V_{GS}=0V,$ $V_{DS}=50V,$ Frequency=1.0MHz		310		pF
$C_{oss}$	Output Capacitance			60		
$C_{rss}$	Reverse Transfer Capacitance			15		
$t_{d(ON)}$	Turn-on Delay Time	$V_{DD}=50V, I_{DS}=3A,$ $V_{GEN}=10V, R_G=6\Omega$		7		ns
$t_r$	Turn-on Rise Time			11		
$t_{d(OFF)}$	Turn-off Delay Time			18		
$t_f$	Turn-off Fall Time			9		
<b>Gate Charge Characteristics<sup>(6)</sup></b>						
$Q_g$	Total Gate Charge	$V_{DS}=50V, V_{GS}=10V,$ $I_{DS}=3A$		7		nC
$Q_{gs}$	Gate-Source Charge			1.3		
$Q_{gd}$	Gate-Drain Charge			1.4		

- Notes:
- ① Pulse width limited by safe operating area.
  - ② Calculated continuous current based on maximum allowable junction temperature.
  - ③ When mounted on 1 inch square copper board,  $t \leq 10\text{sec}$ . The value in any given application depends on the user's specific board design.
  - ④ Limited by  $T_{Jmax}$ , starting  $T_J = 25^\circ\text{C}$ .
  - ⑤ Pulse test; Pulse width  $\leq 300\mu s$ , duty cycle  $\leq 2\%$ .
  - ⑥ Guaranteed by design, not subject to production testing.

**Ordering and Marking Information**

Device	Package	Packaging	Quantity	Reel Size	Tape width
KS1260HAT	SOP8	Tape&Reel	3000	13"	12mm

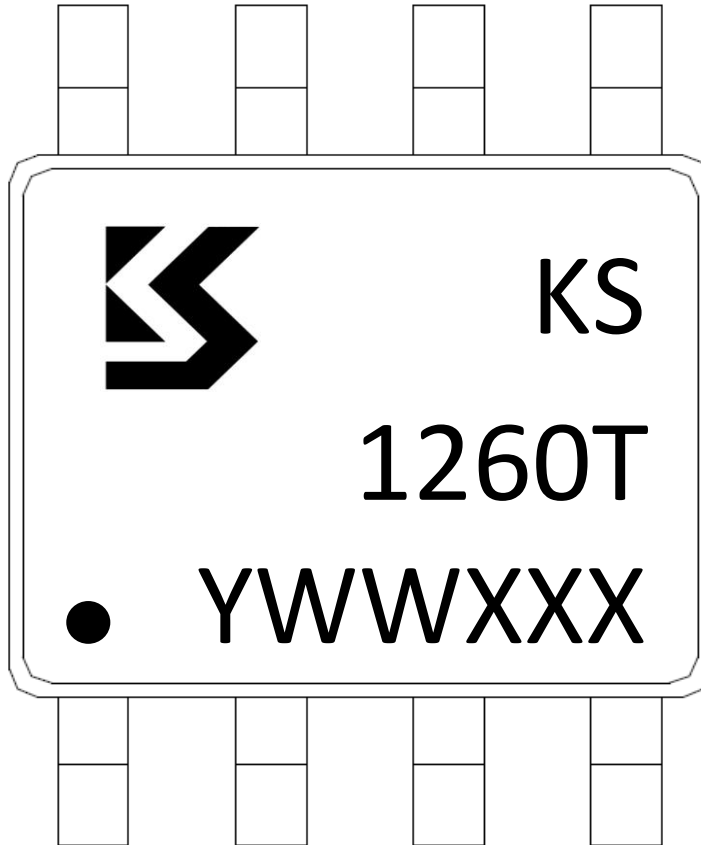

1st Line: Kwansemi LOGO, Kwansemi Code(KS)

2nd Line: Part Number(1260T)

3rd Line: Lot Number(YWWXXX)

### Typical Characteristics

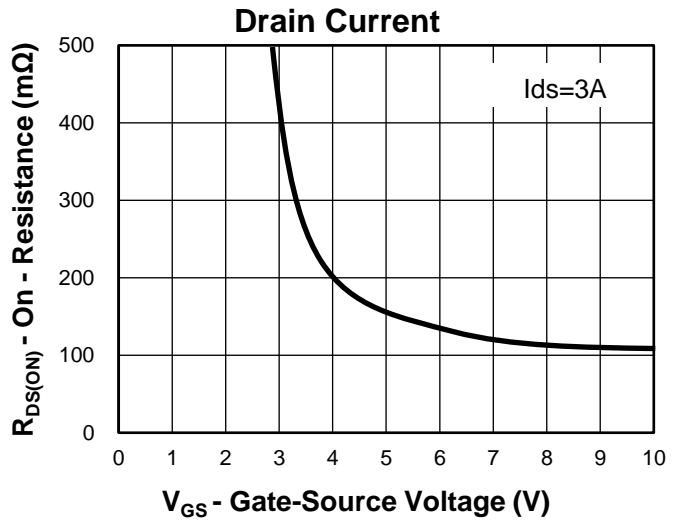
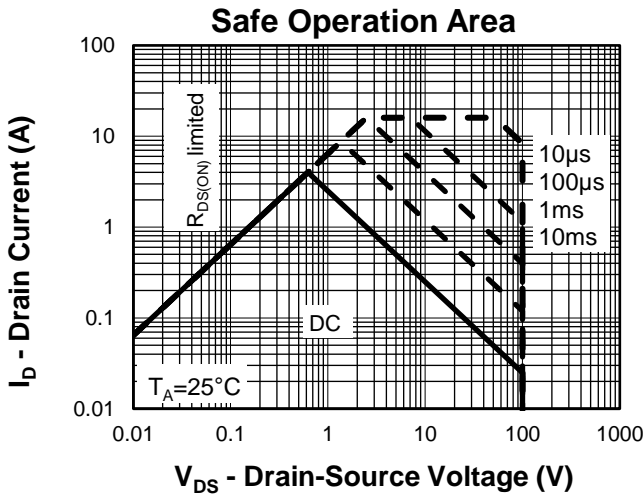
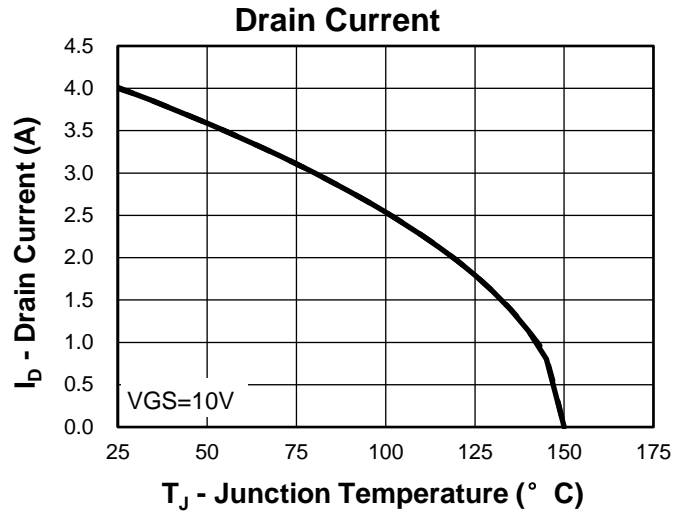
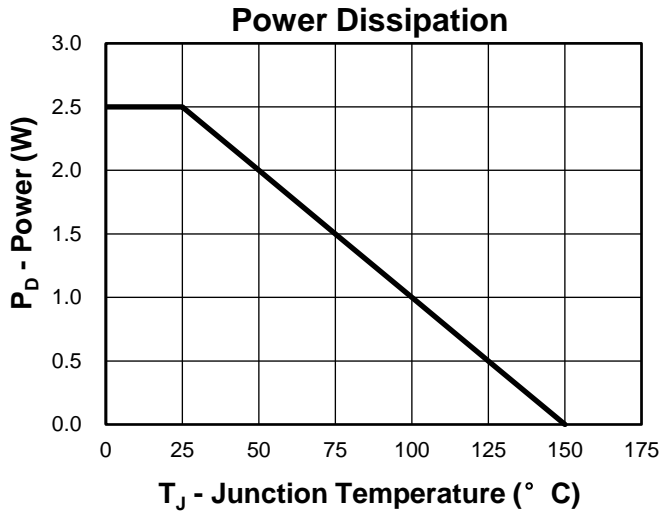

### Thermal Transient Impedance

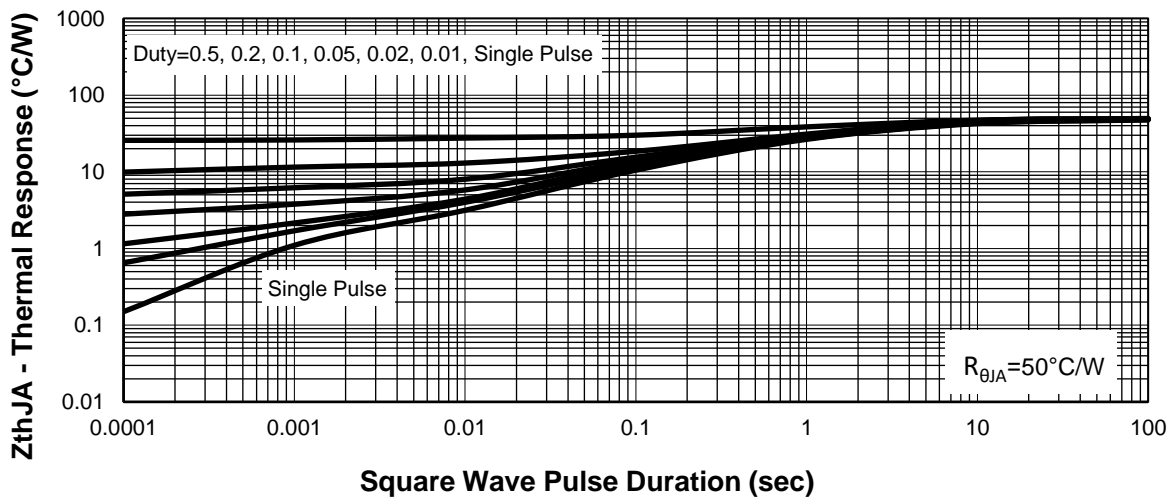

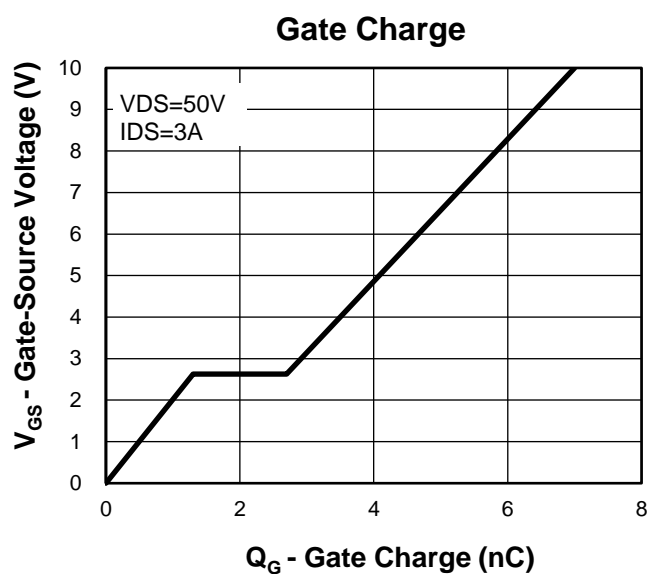
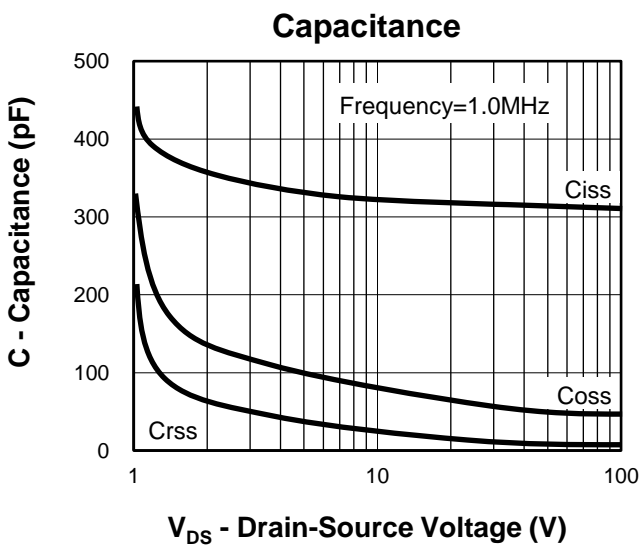
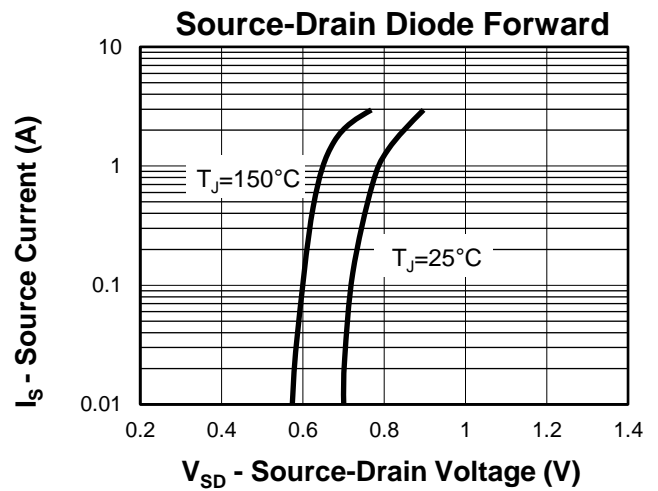
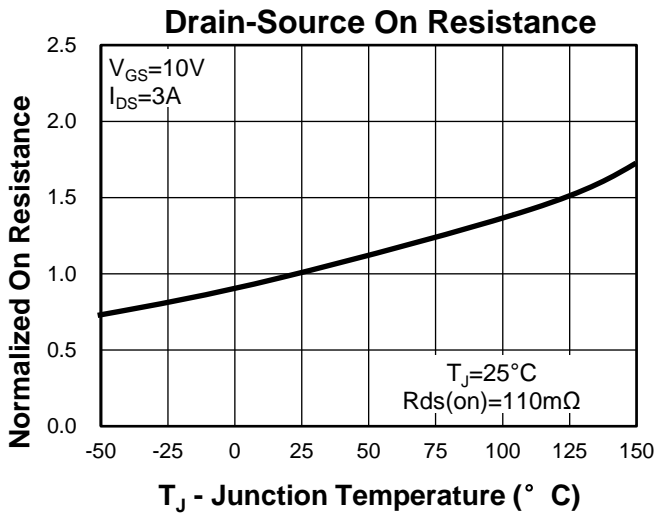
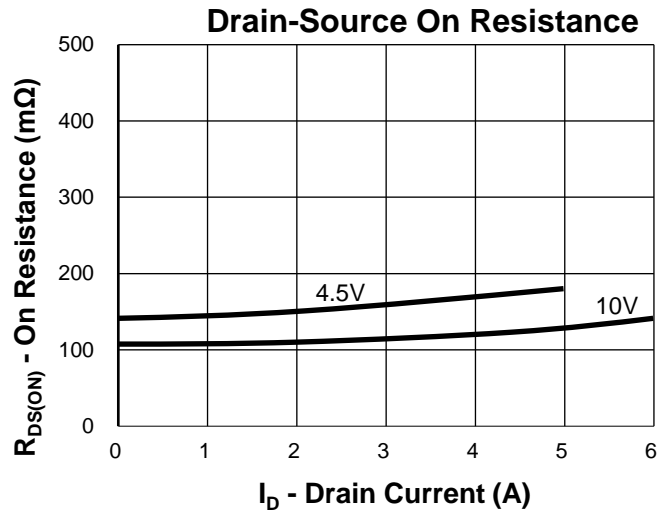
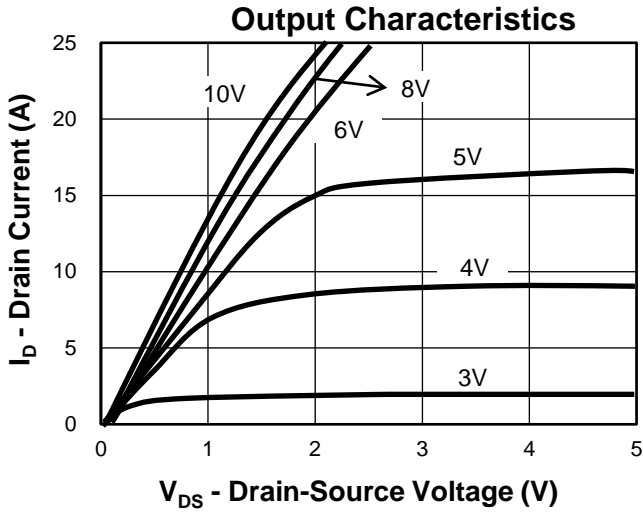
**Typical Characteristics**

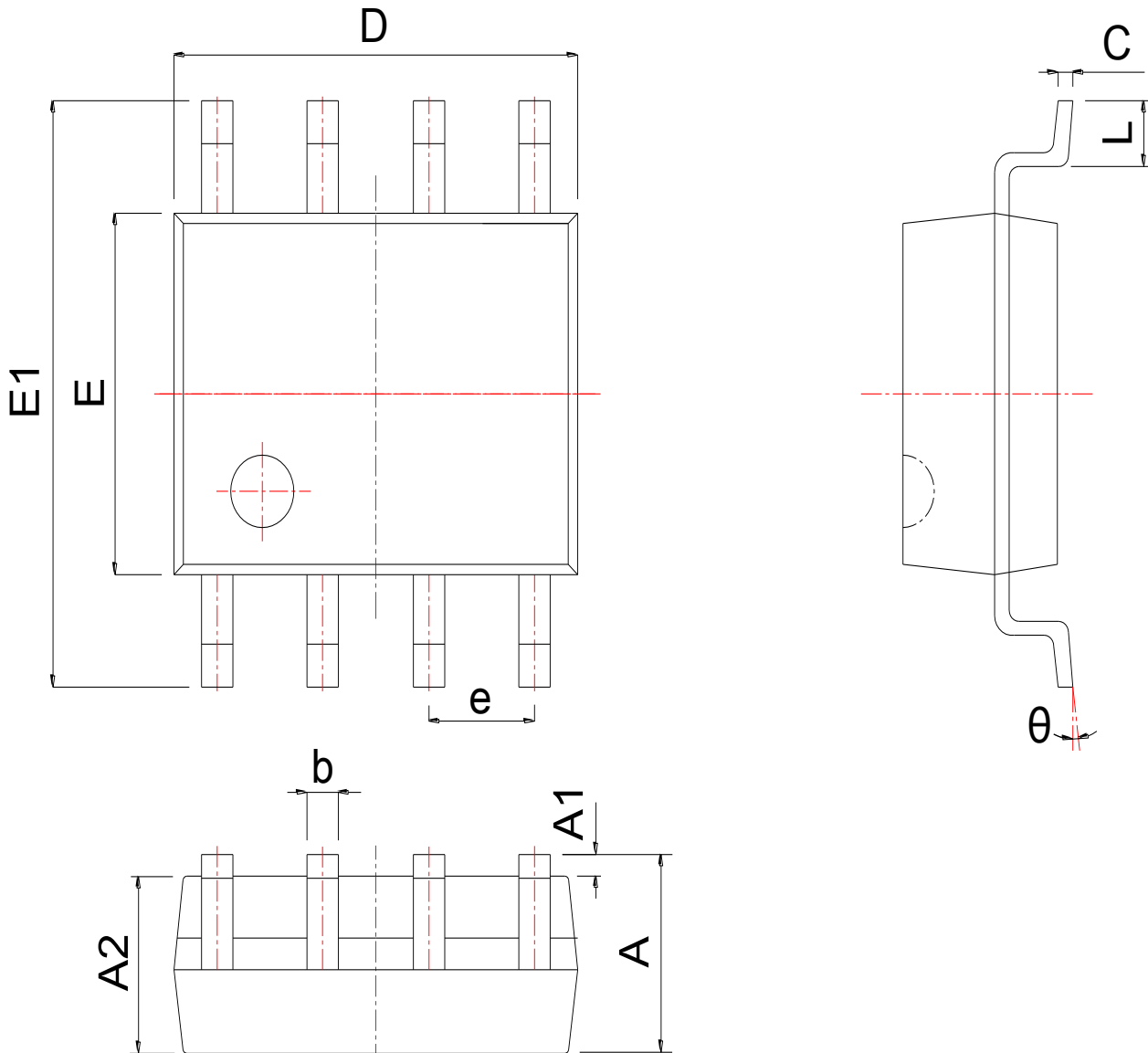
**Package Information**
**SOP8**

SYMBOL	MM			INCH		
	MIN	NOM	MAX	MIN	NOM	MAX
A	1.300	1.525	1.750	0.051	0.060	0.069
A1	0.050	0.150	0.250	0.002	0.006	0.010
A2	1.350	1.450	1.550	0.053	0.057	0.061
b	0.330	0.420	0.510	0.013	0.017	0.020
c	0.170	0.210	0.250	0.007	0.008	0.010
D	4.700	4.900	5.100	0.185	0.193	0.201
E	3.800	3.900	4.000	0.150	0.154	0.157
E1	5.800	6.000	6.200	0.228	0.236	0.244
e	1.270 BSC			0.050 BSC		
L	0.400	0.835	1.270	0.016	0.033	0.050
θ	0°		8°	0°		8°

### Avalanche Test Circuit and Waveforms



### Switching Time Test Circuit and Waveforms



### Diode Recovery Test Circuit and Waveforms

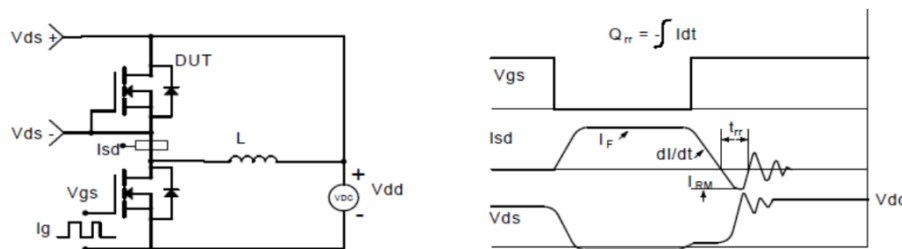

### Gate Charge Test Circuit and Waveform

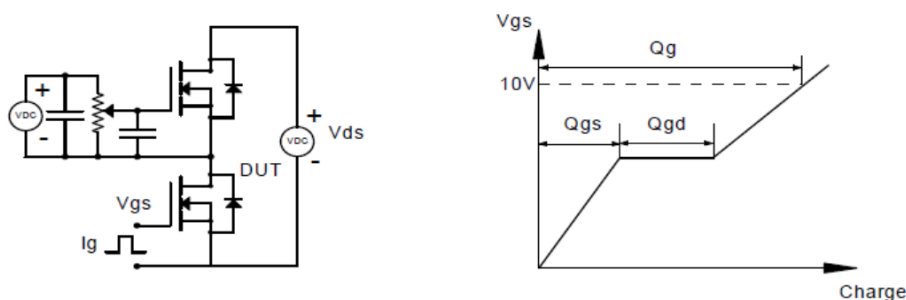

### Customer Service

Kwansemi Semiconductor Co.,Ltd

Email:Sales@kwansemi.com

Web:www.kwansemi.com

### DISCLAIMER:

Kwansemi reserves the right to change the specifications and circuitry without notice at any time. The Products are not designed for use in hostile environments, including, without limitation, aircraft, nuclear power generation, medical appliances, and devices or systems in which malfunction of any Product can reasonably be expected to result in a personal injury. Seller's customers using or selling Seller's products for use in such applications do so at their own risk and agree to fully defend and indemnify Seller.