

Features

- 40V/11A,
 $R_{DS(ON)} = 9m\Omega(Typ.)@V_{GS}=10V$
 $R_{DS(ON)} = 13m\Omega(Typ.)@V_{GS}=4.5V$
- Excellent $Q_G \times R_{DS(on)}$ product(FOM)
- SGT Technology
- Fast Switching Speed
- Low Capacitance to Minimize Driver Losses

Applications

- Switch Mode Power Supply



Pin Description

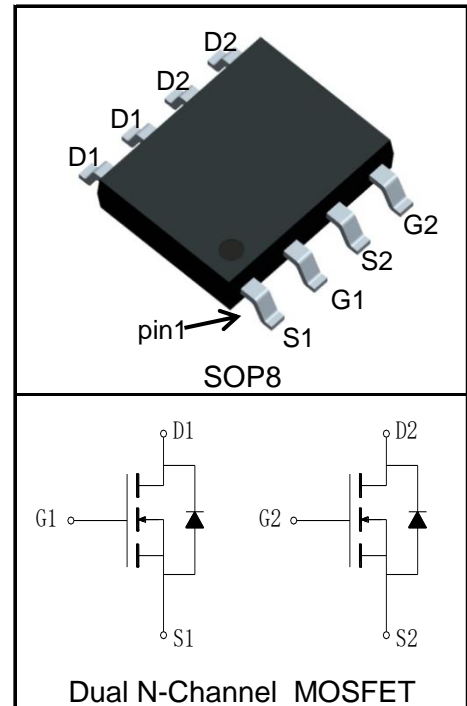

Absolute Maximum Ratings

Symbol	Parameter	Rating	Unit
Common Ratings ($T_A=25^\circ C$ Unless Otherwise Noted)			
V_{DSS}	Drain-Source Voltage	40	V
V_{GSS}	Gate-Source Voltage	± 20	
T_J	Maximum Junction Temperature	150	$^\circ C$
T_{STG}	Storage Temperature Range	-55 to 150	$^\circ C$
I_S	Diode Continuous Forward Current	$T_A=25^\circ C$	2.4 A
Mounted on Large Heat Sink			
$I_{DP}^{(1)}$	300 μs Pulse Drain Current Tested	$T_A=25^\circ C$	44 A
$I_D^{(2)}$	Continuous Drain Current($V_{GS}=10V$)	$T_A=25^\circ C$	11 A
		$T_A=70^\circ C$	8.8 A
P_D	Maximum Power Dissipation	$T_A=25^\circ C$	2 W
		$T_A=70^\circ C$	1.3 W
$R_{\theta JL}$	Thermal Resistance-Junction to Lead	40	$^\circ C/W$
$R_{\theta JA}^{(3)}$	Thermal Resistance-Junction to Ambient	62.5	$^\circ C/W$
Drain-Source Avalanche Ratings			
$E_{AS}^{(4)}$	Avalanche Energy, Single Pulsed	9	mJ

Electrical Characteristics ($T_A=25^\circ\text{C}$ Unless Otherwise Noted)

Symbol	Parameter	Test Condition	KS4425HAT			Unit
			Min.	Typ.	Max.	
Static Characteristics						
BV_{DSS}	Drain-Source Breakdown Voltage	$V_{GS}=0V, I_{DS}=250\mu A$	40			V
I_{DSS}	Zero Gate Voltage Drain Current	$V_{DS}=40V, V_{GS}=0V$			1	μA
		$T_J=125^\circ\text{C}$			30	
$V_{GS(th)}$	Gate Threshold Voltage	$V_{DS}=V_{GS}, I_{DS}=250\mu A$	1.1	1.6	2.3	V
I_{GSS}	Gate Leakage Current	$V_{GS}=\pm 20V, V_{DS}=0V$			± 100	nA
$R_{DS(ON)}^{(5)}$	Drain-Source On-state Resistance	$V_{GS}=10V, I_{DS}=10A$		9	12	$m\Omega$
		$V_{GS}=4.5V, I_{DS}=6A$		13	18	$m\Omega$
Diode Characteristics						
$V_{SD}^{(5)}$	Diode Forward Voltage	$I_{SD}=10A, V_{GS}=0V$		0.85	1.2	V
t_{rr}	Reverse Recovery Time	$I_{SD}=10A, dI_{SD}/dt=100A/\mu s$		11		ns
Q_{rr}	Reverse Recovery Charge			22		nC
Dynamic Characteristics⁽⁶⁾						
R_G	Gate Resistance	$V_{GS}=0V, V_{DS}=0V, F=1\text{MHz}$		1		Ω
C_{iss}	Input Capacitance	$V_{GS}=0V,$ $V_{DS}=20V,$ Frequency=1.0MHz		995		pF
C_{oss}	Output Capacitance			200		
C_{rss}	Reverse Transfer Capacitance			15		
$t_{d(ON)}$	Turn-on Delay Time	$V_{DD}=20V, I_{DS}=10A,$ $V_{GEN}=10V, R_G=6\Omega$		7		ns
t_r	Turn-on Rise Time			8		
$t_{d(OFF)}$	Turn-off Delay Time			13		
t_f	Turn-off Fall Time			5		
Gate Charge Characteristics⁽⁶⁾						
Q_g	Total Gate Charge	$V_{DS}=20V, V_{GS}=10V,$ $I_{DS}=10A$		10		nC
Q_{gs}	Gate-Source Charge			3.1		
Q_{gd}	Gate-Drain Charge			1.7		

- Notes:
- ① Pulse width limited by safe operating area.
 - ② Calculated continuous current based on maximum allowable junction temperature.
 - ③ When mounted on 1 inch square copper board, $t \leq 10\text{sec}$. The value in any given application depends on the user's specific board design.
 - ④ Limited by T_{Jmax} , starting $T_J = 25^\circ\text{C}$, $L = 0.5\text{mH}$, $R_G = 25\Omega$, $I_{AS} = 6A$, $V_{GS} = 10V$.
 - ⑤ Pulse test; Pulse width $\leq 300\mu s$, duty cycle $\leq 2\%$.
 - ⑥ Guaranteed by design, not subject to production testing.

Ordering and Marking Information

Device	Package	Packaging	Quantity	Reel Size	Tape width
KS4425HAT	SOP8	Tape&Reel	3000	13"	12mm

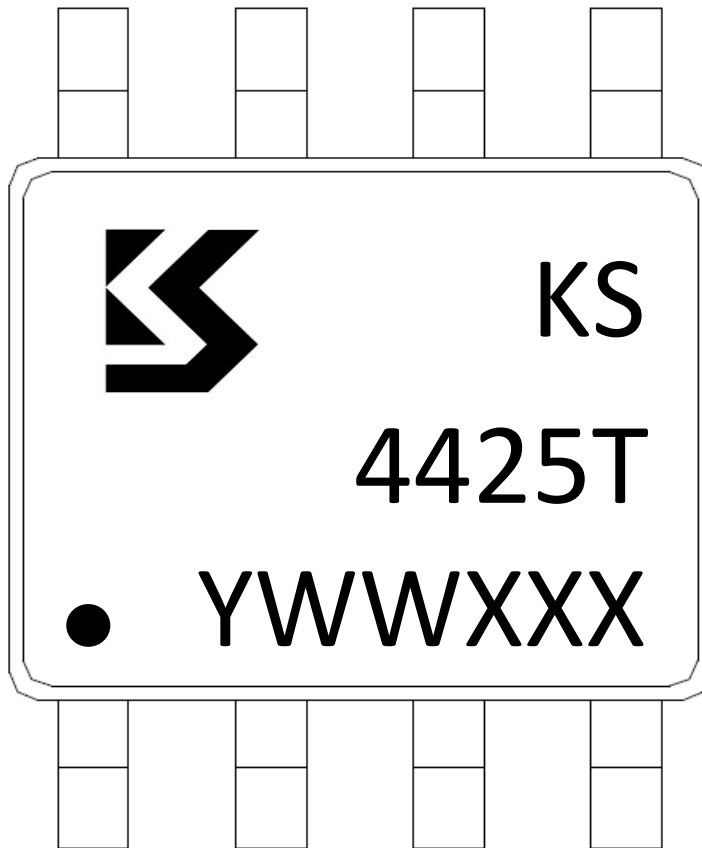

1st Line: Kwansemi LOGO, Kwansemi Code(KS)

2nd Line: Part Number(4425T)

3rd Line: Lot Number(YWWXXX)

Typical Characteristics

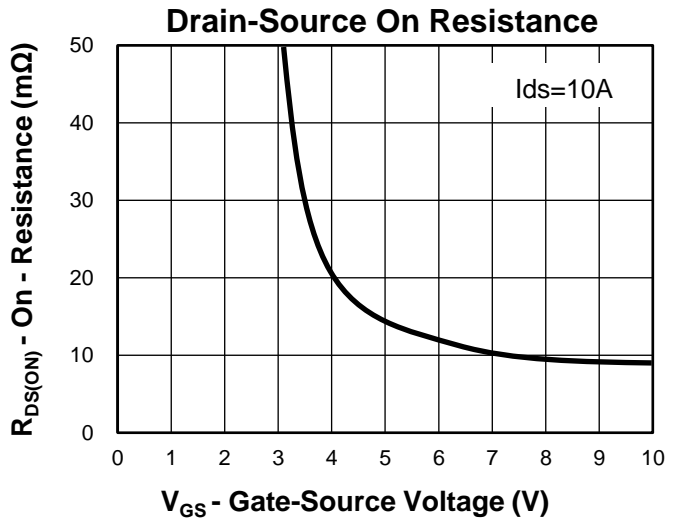
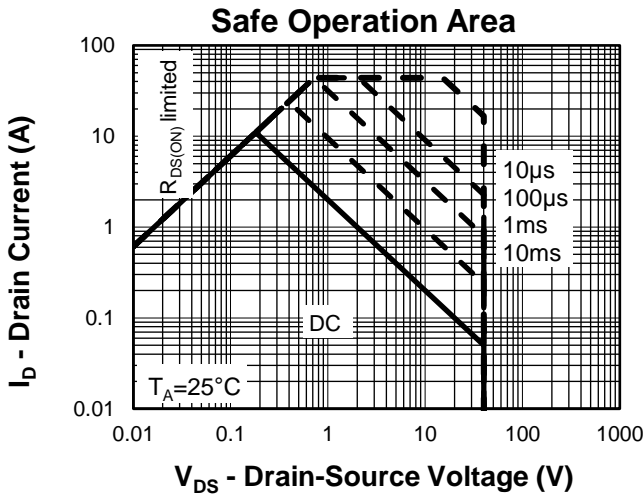
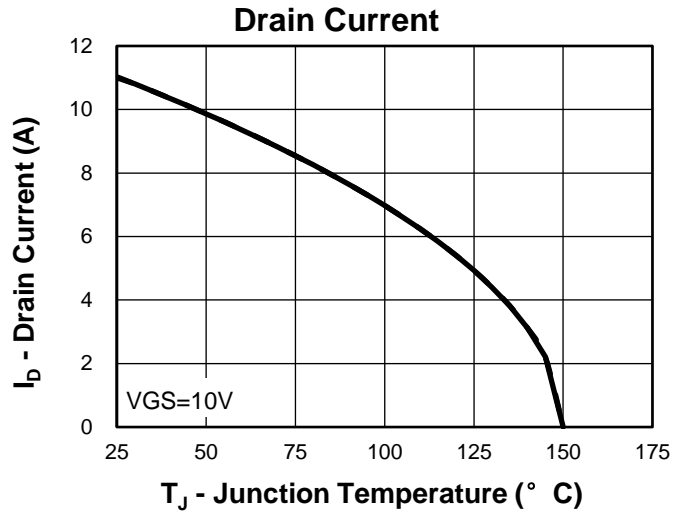
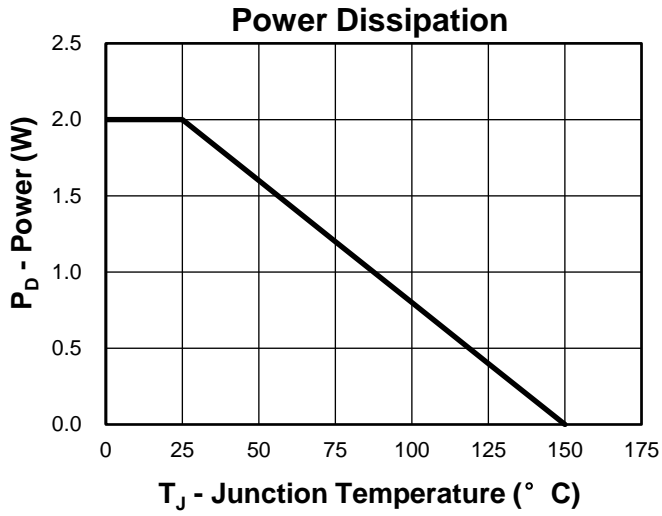

Thermal Transient Impedance

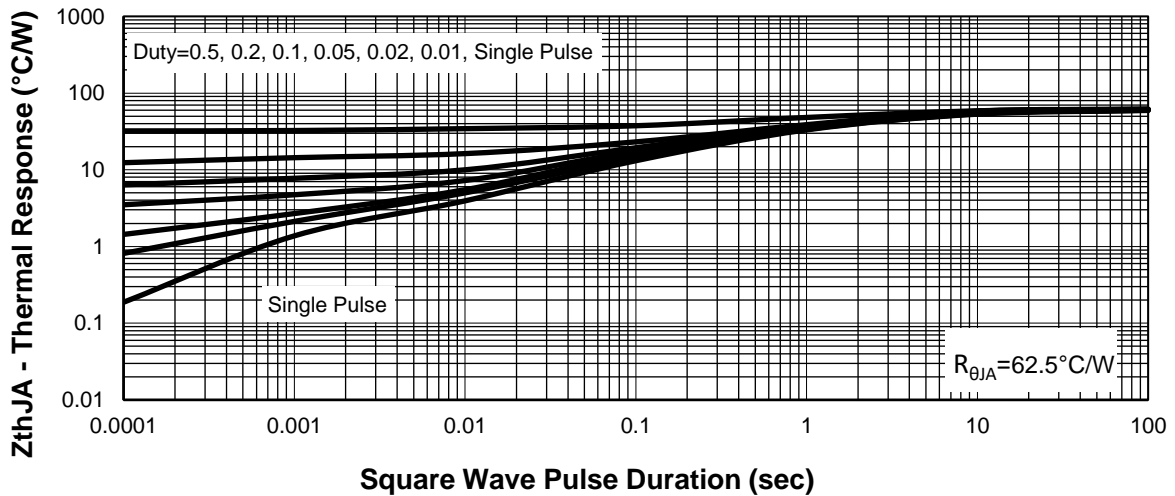

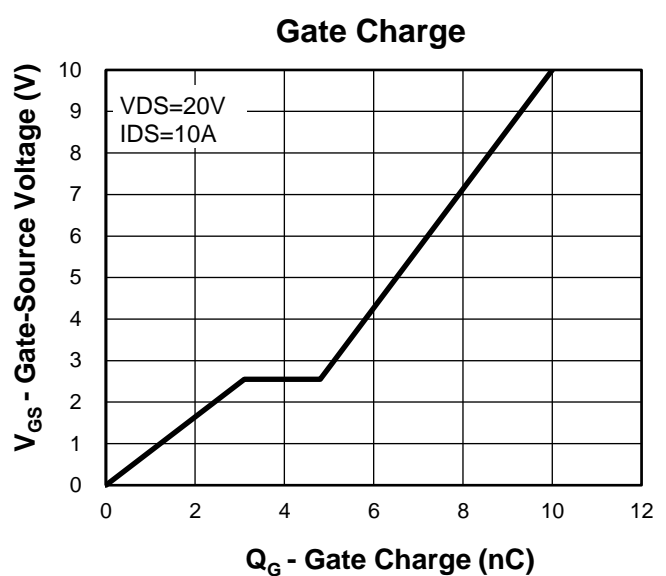
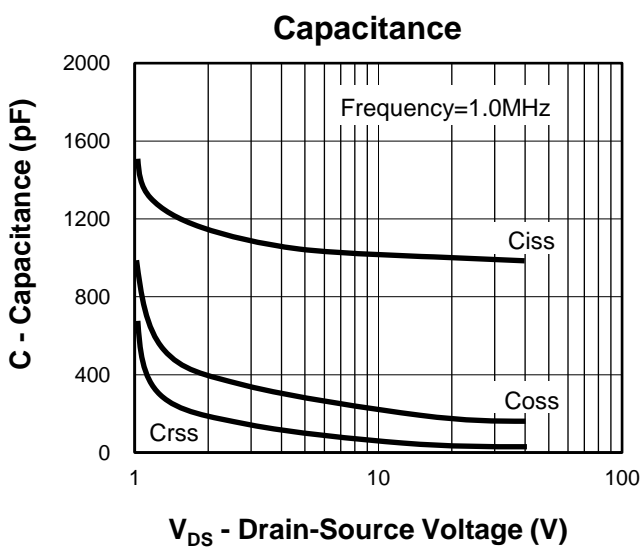
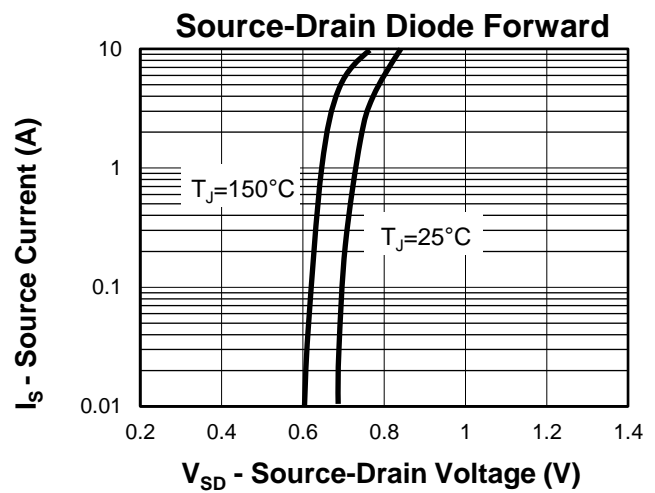
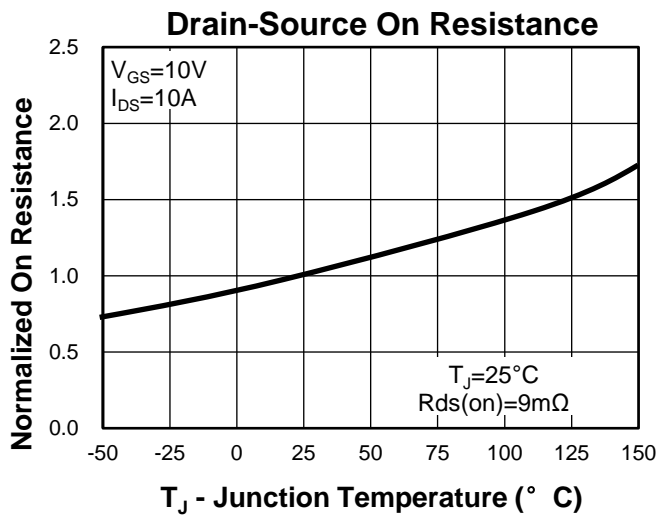
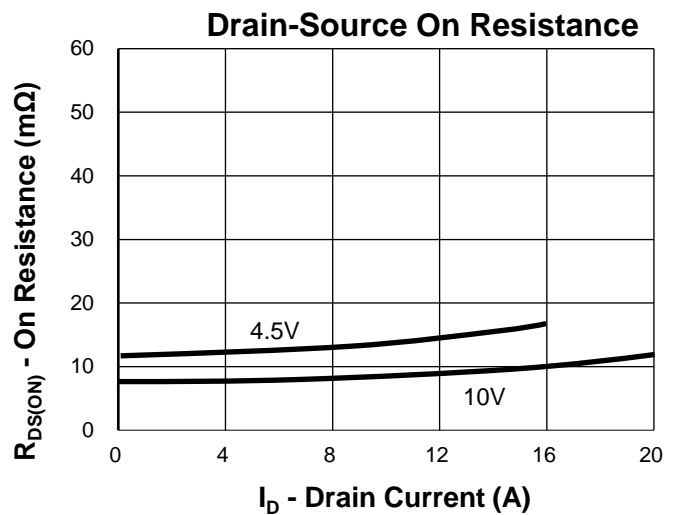
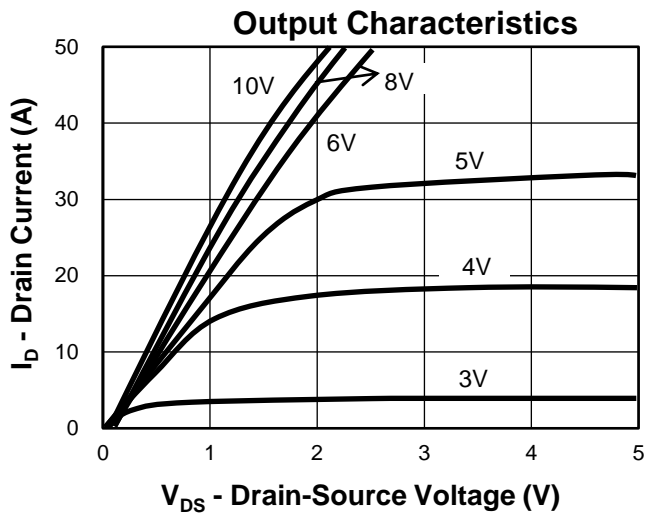
Typical Characteristics

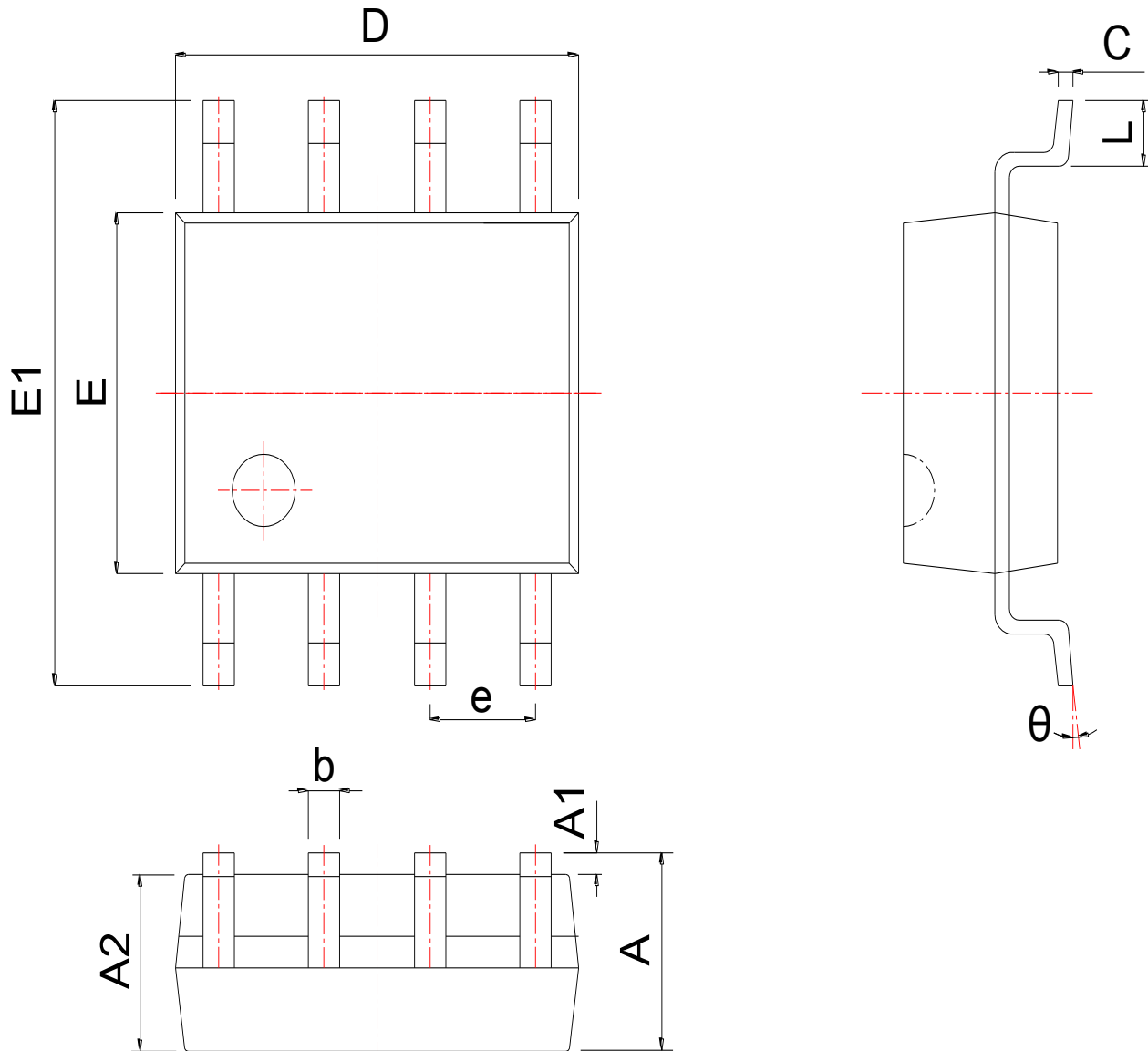
Package Information
SOP8

SYMBOL	MM			INCH		
	MIN	NOM	MAX	MIN	NOM	MAX
A	1.300	1.525	1.750	0.051	0.060	0.069
A1	0.050	0.150	0.250	0.002	0.006	0.010
A2	1.350	1.450	1.550	0.053	0.057	0.061
b	0.330	0.420	0.510	0.013	0.017	0.020
c	0.170	0.210	0.250	0.007	0.008	0.010
D	4.700	4.900	5.100	0.185	0.193	0.201
E	3.800	3.900	4.000	0.150	0.154	0.157
E1	5.800	6.000	6.200	0.228	0.236	0.244
e	1.270 BSC			0.050 BSC		
L	0.400	0.835	1.270	0.016	0.033	0.050
theta	0°		8°	0°		8°

Avalanche Test Circuit and Waveforms

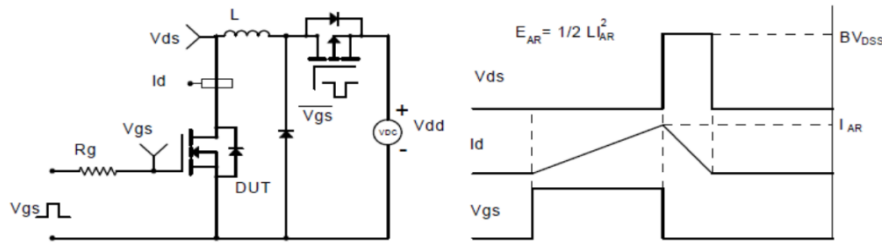

Switching Time Test Circuit and Waveforms

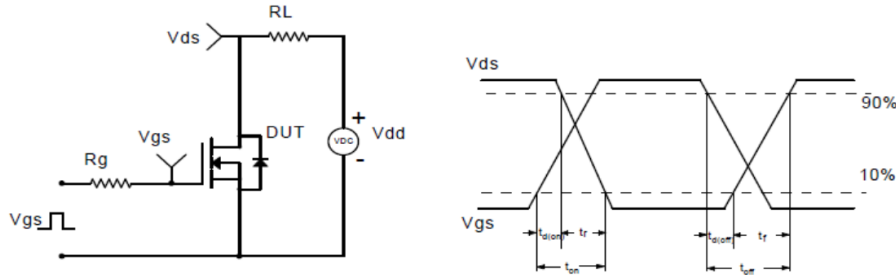

Diode Recovery Test Circuit and Waveforms



Gate Charge Test Circuit and Waveform



Customer Service

Kwansemi Semiconductor Co.,Ltd

Email:Sales@kwansemi.com

Web:www.kwansemi.com

DISCLAIMER:

Kwansemi reserves the right to change the specifications and circuitry without notice at any time. The Products are not designed for use in hostile environments, including, without limitation, aircraft, nuclear power generation, medical appliances, and devices or systems in which malfunction of any Product can reasonably be expected to result in a personal injury. Seller's customers using or selling Seller's products for use in such applications do so at their own risk and agree to fully defend and indemnify Seller.