

Features

- 100V/290A,
 $R_{DS(on)} = 2.3m\Omega(Typ.)@V_{GS}=10V$
- Excellent $Q_G \times R_{DS(on)}$ product(FOM)
- SGT Technology
- High Ruggedness
- 100% Avalanche Tested

Applications

- Motor Control
- Battery Power Management



Halogen-Free

Pin Description

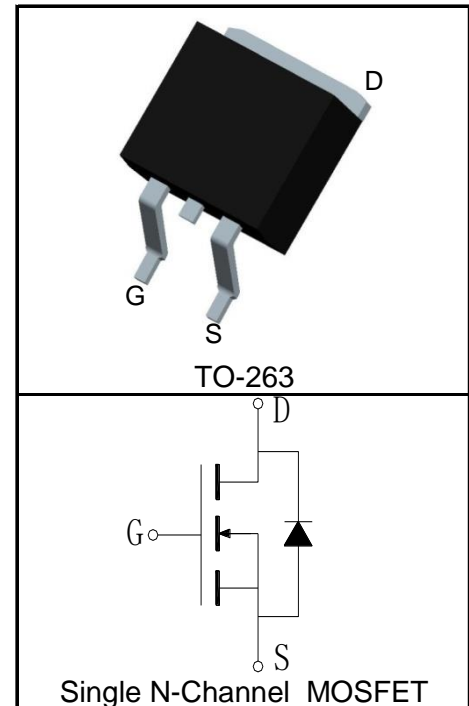

Absolute Maximum Ratings

Symbol	Parameter	Rating	Unit
Common Ratings ($T_C=25^\circ\text{C}$ Unless Otherwise Noted)			
V_{DSS}	Drain-Source Voltage	100	V
V_{GSS}	Gate-Source Voltage	± 20	
T_J	Maximum Junction Temperature	175	$^\circ\text{C}$
T_{STG}	Storage Temperature Range	-55 to 175	$^\circ\text{C}$
I_S	Diode Continuous Forward Current	$T_C=25^\circ\text{C}$ 290	A
Mounted on Large Heat Sink			
$I_{DP}^{(1)}$	300 μs Pulse Drain Current Tested	$T_C=25^\circ\text{C}$ 1160	A
$I_D^{(2)}$	Continuous Drain Current($V_{GS}=10V$)	$T_C=25^\circ\text{C}$ 290	A
		$T_C=100^\circ\text{C}$ 205	
P_D	Maximum Power Dissipation	$T_C=25^\circ\text{C}$ 395	W
		$T_C=100^\circ\text{C}$ 197	
$R_{\theta JC}$	Thermal Resistance-Junction to Case	0.38	$^\circ\text{C}/\text{W}$
$R_{\theta JA}^{(3)}$	Thermal Resistance-Junction to Ambient	62.5	$^\circ\text{C}/\text{W}$
Drain-Source Avalanche Ratings			
$E_{AS}^{(4)}$	Avalanche Energy, Single Pulsed	625	mJ

Electrical Characteristics ($T_C=25^\circ\text{C}$ Unless Otherwise Noted)

Symbol	Parameter	Test Condition	KS12009GAT			Unit
			Min.	Typ.	Max.	
Static Characteristics						
BV_{DSS}	Drain-Source Breakdown Voltage	$V_{GS}=0V, I_{DS}=250\mu A$	100			V
I_{DSS}	Zero Gate Voltage Drain Current	$V_{DS}=100V, V_{GS}=0V$			1	μA
		$T_J=125^\circ C$			30	
$V_{GS(th)}$	Gate Threshold Voltage	$V_{DS}=V_{GS}, I_{DS}=250\mu A$	2	3	4	V
I_{GSS}	Gate Leakage Current	$V_{GS}=\pm 20V, V_{DS}=0V$			± 100	nA
$R_{DS(ON)}^{(5)}$	Drain-Source On-state Resistance	$V_{GS}=10V, I_{DS}=40A$		2.3	2.8	m Ω
Diode Characteristics						
$V_{SD}^{(5)}$	Diode Forward Voltage	$I_{SD}=40A, V_{GS}=0V$		0.8	1.2	V
t_{rr}	Reverse Recovery Time	$I_{SD}=40A, dI_{SD}/dt=100A/\mu s$		80		ns
Q_{rr}	Reverse Recovery Charge			177		nC
Dynamic Characteristics⁽⁶⁾						
R_G	Gate Resistance	$V_{GS}=0V, V_{DS}=0V, F=1MHz$		1.9		Ω
C_{iss}	Input Capacitance	$V_{GS}=0V,$ $V_{DS}=50V,$ Frequency=1.0MHz		12210		pF
C_{oss}	Output Capacitance			2100		
C_{riss}	Reverse Transfer Capacitance			135		
$t_{d(ON)}$	Turn-on Delay Time	$V_{DD}=50V, I_{DS}=40A,$ $V_{GEN}=10V, R_G=3\Omega$		32		ns
t_r	Turn-on Rise Time			44		
$t_{d(OFF)}$	Turn-off Delay Time			118		
t_f	Turn-off Fall Time			53		
Gate Charge Characteristics⁽⁶⁾						
Q_g	Total Gate Charge	$V_{DS}=50V, V_{GS}=10V,$ $I_{DS}=40A$		172		nC
Q_{gs}	Gate-Source Charge			48		
Q_{gd}	Gate-Drain Charge			39		

- Notes:
- ① Pulse width limited by safe operating area.
 - ② Calculated continuous current based on maximum allowable junction temperature.
 - ③ When mounted on 1 inch square copper board, $t \leq 10\text{sec}$. The value in any given application depends on the user's specific board design.
 - ④ Limited by $T_{Jmax}, I_{AS}=50A, L=0.5mH, V_{DD}=48V, R_G=25\Omega$, Starting $T_J=25^\circ C$, 100% tested and guaranteed.
 - ⑤ Pulse test; Pulse width $\leq 300\mu s$, duty cycle $\leq 2\%$.
 - ⑥ Guaranteed by design, not subject to production testing.

Ordering and Marking Information

Device	Package	Packaging	Quantity	Reel Size	Tape width
KS12009GAT	TO-263	Tape&Reel	800	13"	24mm

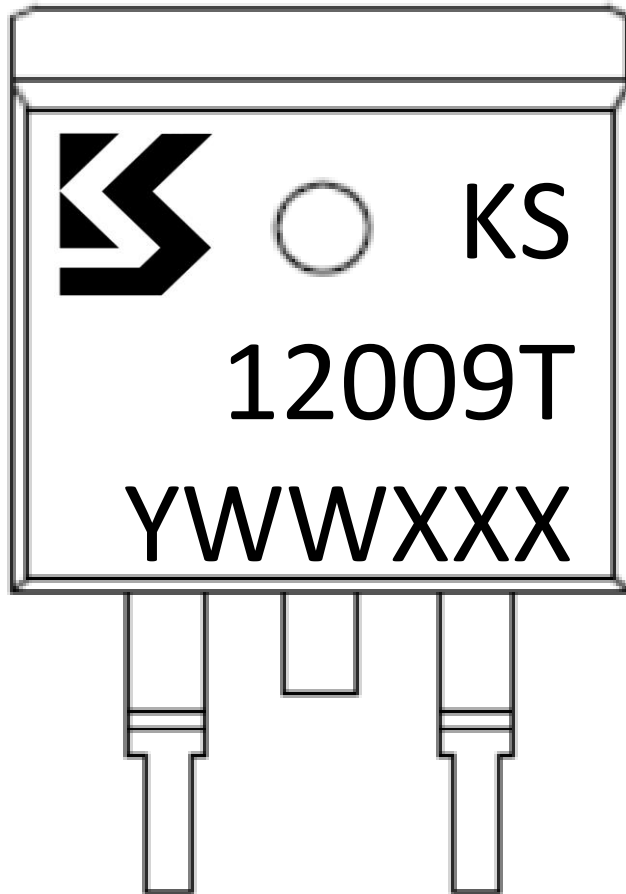

1st Line: Kwansemi LOGO, Kwansemi Code(KS)

2nd Line: Part Number(12009T)

3rd Line: Lot Number(YWWXXX)

Typical Characteristics

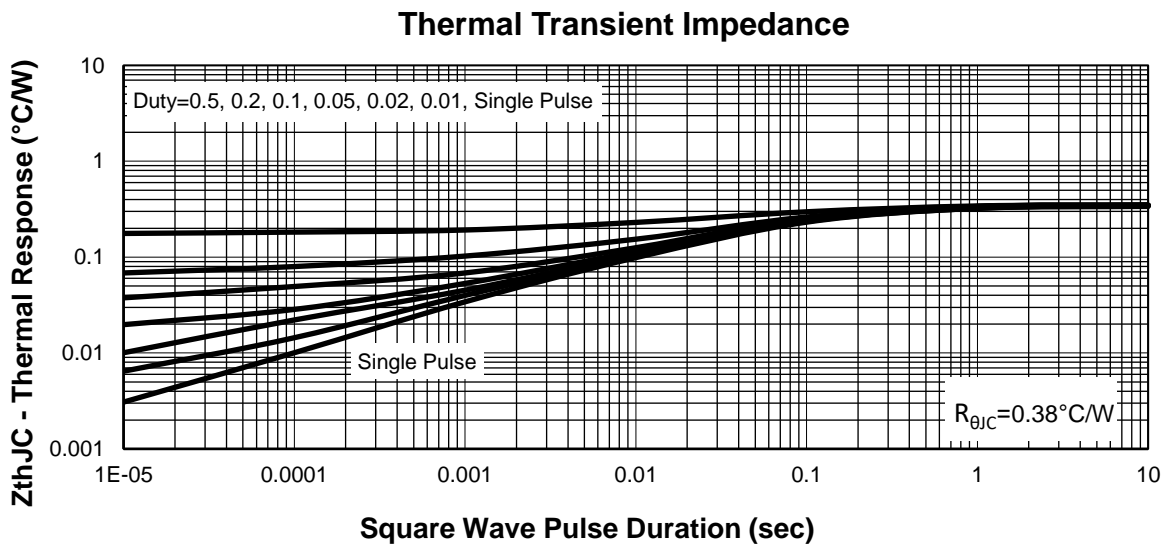
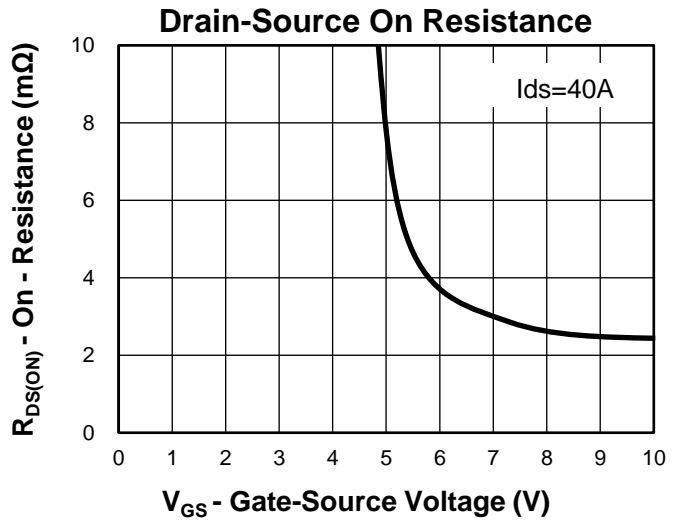
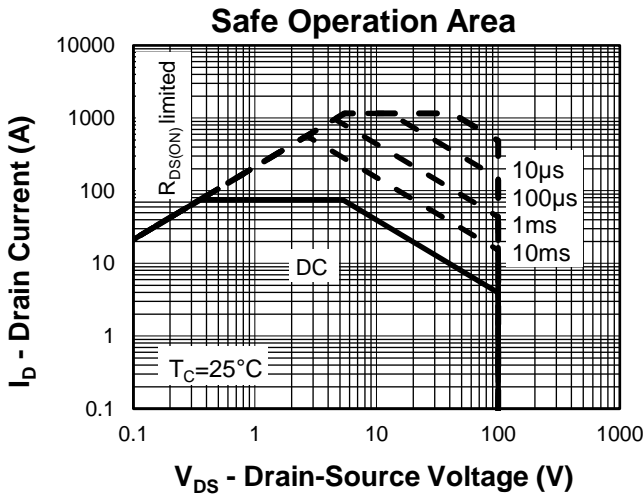
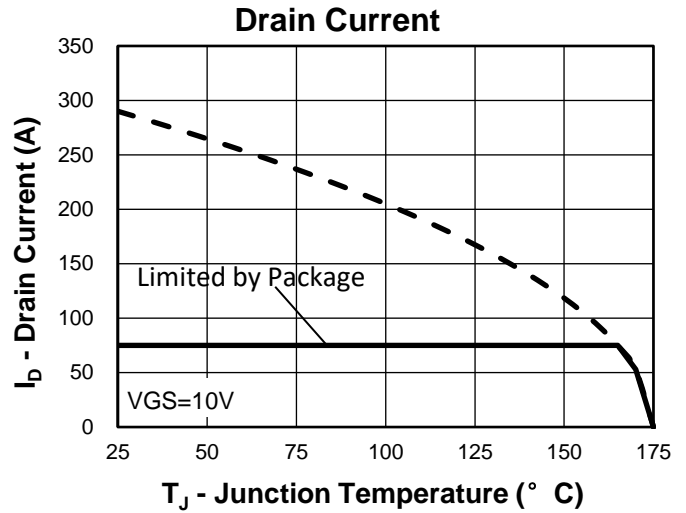
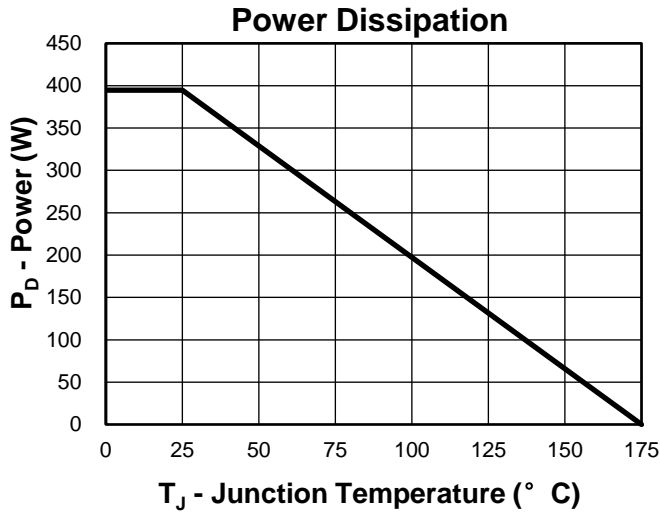

Typical Characteristics

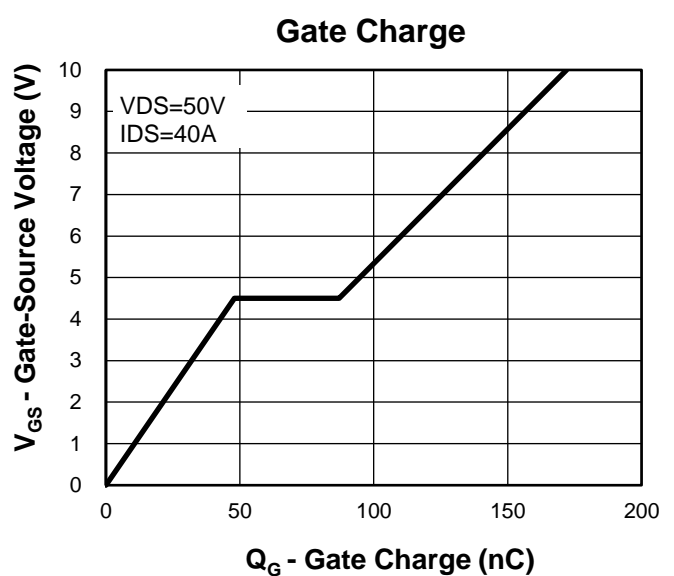
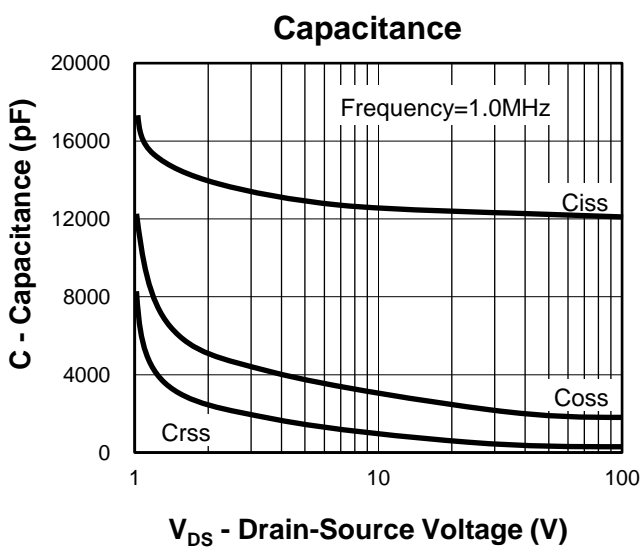
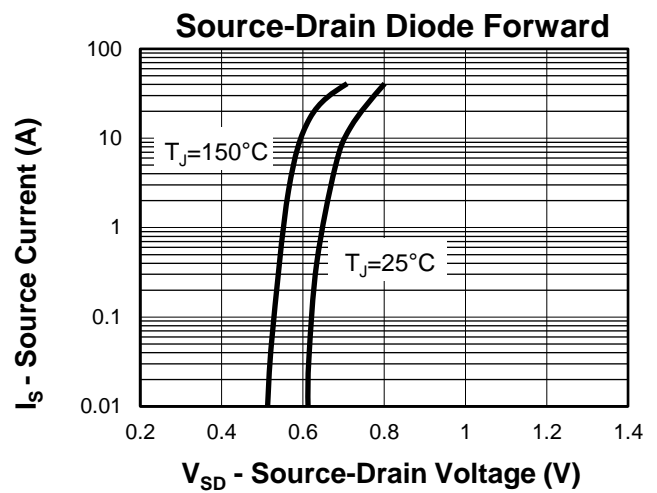
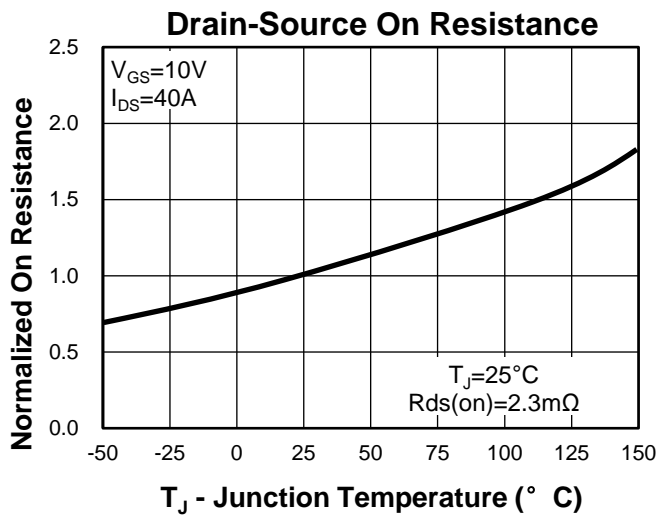
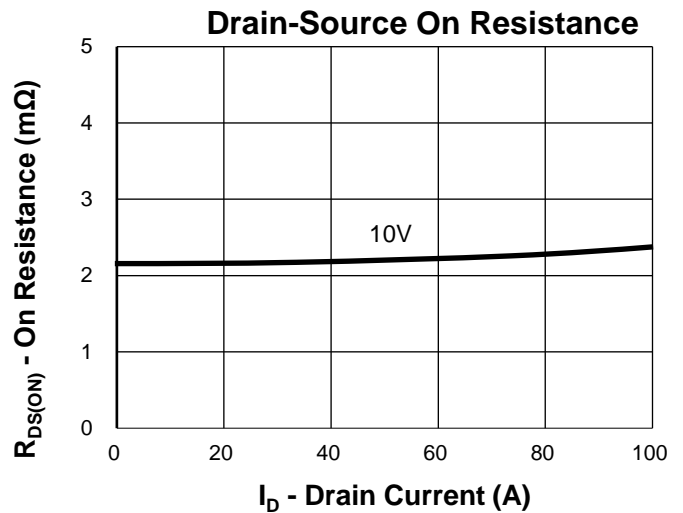
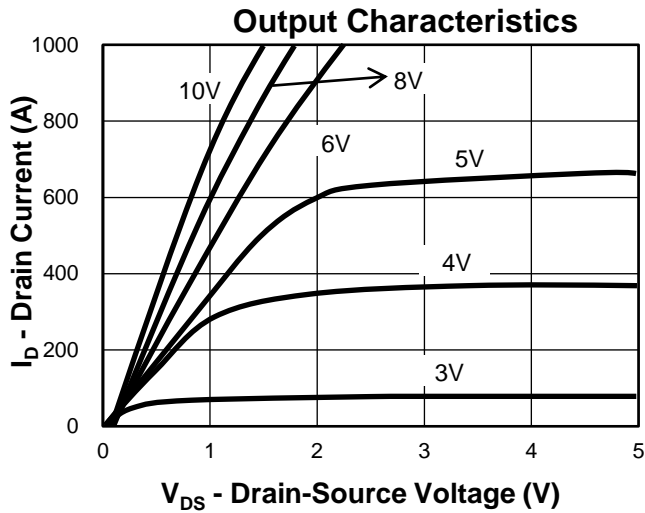

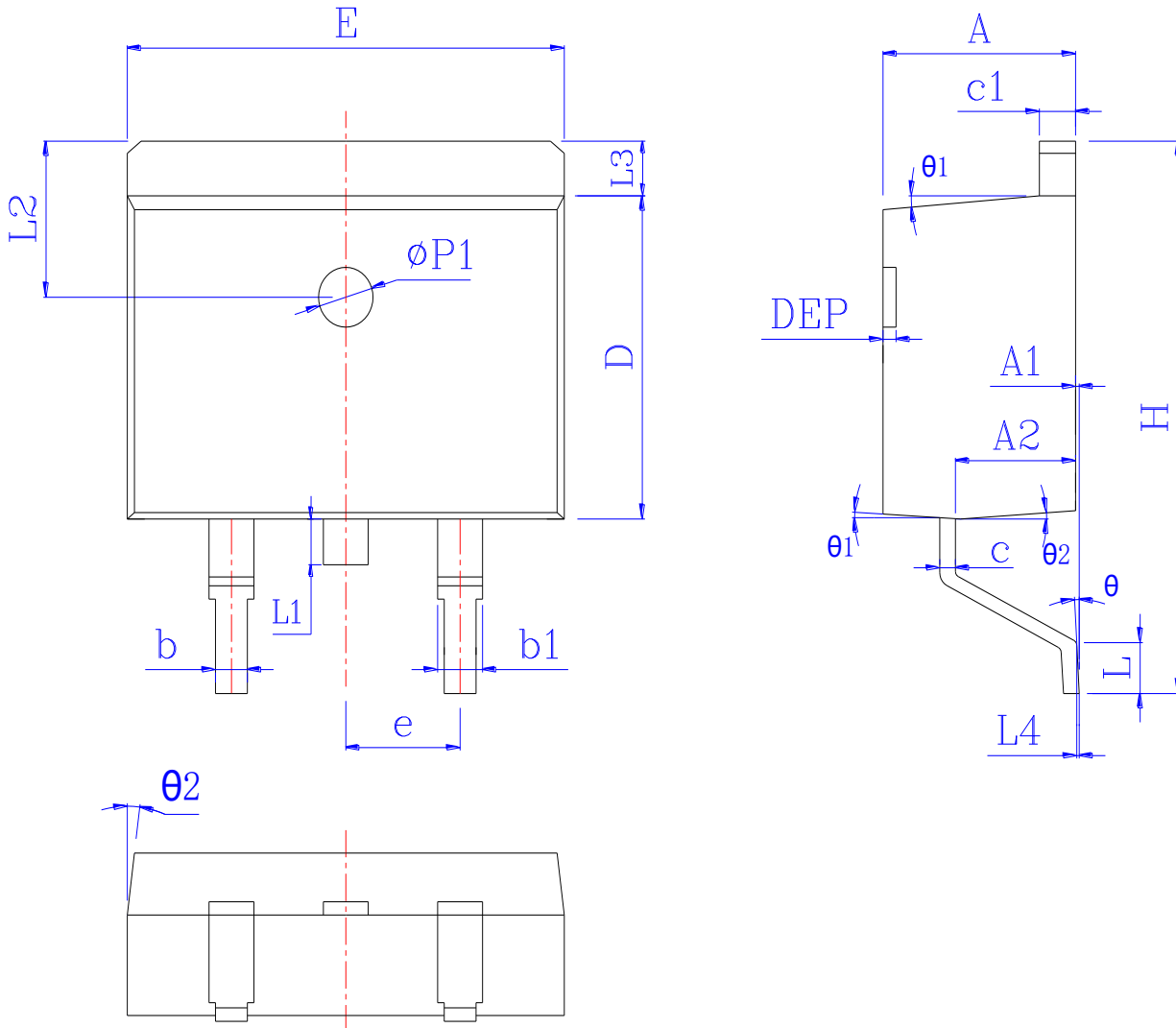
Package Information
TO-263

SYMBOL	MM			INCH			SYMBOL	MM			INCH		
	MIN	NOM	MAX	MIN	NOM	MAX		MIN	NOM	MAX	MIN	NOM	MAX
A	4.40	4.55	4.72	0.173	0.179	0.186	L	1.94	2.30	2.60	0.076	0.091	0.102
A1	0.00	0.10	0.25	0.000	0.005	0.010	L3	1.17	1.29	1.40	0.046	0.051	0.055
A2	2.59	2.69	2.79	0.102	0.106	0.110	L1	*	*	1.70	*	*	0.067
b	0.76	*	0.90	0.030	*	0.035	L4	0.25 BSC			0.01 BSC		
b1	1.22	*	1.36	0.048	*	0.054	L2	2.50 REF			0.098 REF		
c	0.33	*	0.47	0.013	*	0.019	θ	0°	*	8°	0°	*	8°
c1	1.22	*	1.32	0.048	*	0.052	$\theta1$	5°	7°	9°	5°	7°	9°
D	8.60	*	9.29	0.339	*	0.366	$\theta2$	1°	3°	5°	1°	3°	5°
E	9.95	*	10.26	0.392	*	0.404	DEP	0.05	0.10	0.20	0.002	0.004	0.008
e	2.54BSC			0.100BSC			$\Phi p1$	1.40	1.50	1.60	0.055	0.059	0.063
H	14.70	15.10	15.79	0.579	0.594	0.622							

Avalanche Test Circuit and Waveforms



Switching Time Test Circuit and Waveforms



Diode Recovery Test Circuit and Waveforms



Gate Charge Test Circuit and Waveform



Customer Service

Kwansemi Semiconductor Co.,Ltd

Email:Sales@kwansemi.com

Web:www.kwansemi.com

DISCLAIMER:

Kwansemi reserves the right to change the specifications and circuitry without notice at any time. The Products are not designed for use in hostile environments, including, without limitation, aircraft, nuclear power generation, medical appliances, and devices or systems in which malfunction of any Product can reasonably be expected to result in a personal injury. Seller's customers using or selling Seller's products for use in such applications do so at their own risk and agree to fully defend and indemnify Seller.