

Features

- -20V/-160A,
 $R_{DS(ON)} = 1.5m\Omega(Typ.)@V_{GS}=-4.5V$
 $R_{DS(ON)} = 2m\Omega(Typ.)@V_{GS}=-2.5V$
 $R_{DS(ON)} = 3.3m\Omega(Typ.)@V_{GS}=-1.8V$
- Ultra Low $R_{DS(ON)}$
- Super High Dense Cell Design
- Fast Switching Speed
- 100% avalanche tested

Applications

- Switching Application Systems



Pin Description

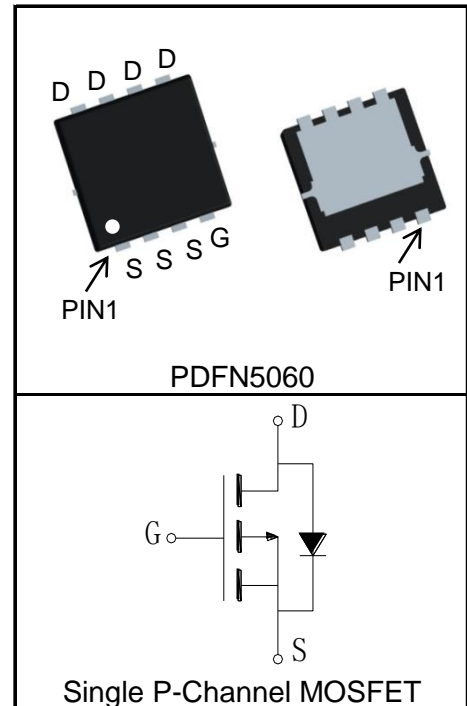

Absolute Maximum Ratings

Symbol	Parameter	Rating	Unit
Common Ratings ($T_C=25^\circ C$ Unless Otherwise Noted)			
V_{DSS}	Drain-Source Voltage	-20	V
V_{GSS}	Gate-Source Voltage	± 12	V
T_J	Maximum Junction Temperature	150	$^\circ C$
T_{STG}	Storage Temperature Range	-55 to 150	$^\circ C$
I_S	Diode Continuous Forward Current	$T_C=25^\circ C$ -160	A
Mounted on Large Heat Sink			
$I_{DP}^{①}$	300 μs Pulse Drain Current Tested	$T_C=25^\circ C$ -640	A
$I_D^{②}$	Continuous Drain Current@ $T_C(V_{GS}=-4.5V)$	$T_C=25^\circ C$ -160	A
		$T_C=100^\circ C$ -101	
	Continuous Drain Current@ $T_A(V_{GS}=-4.5V)^{③}$	$T_A=25^\circ C$ -35	
		$T_A=70^\circ C$ -28	
P_D	Maximum Power Dissipation@ T_C	$T_C=25^\circ C$ 86	W
		$T_C=100^\circ C$ 34	
	Maximum Power Dissipation@ $T_A^{③}$	$T_A=25^\circ C$ 4.2	
		$T_A=70^\circ C$ 2.7	

Symbol	Parameter	Rating	Unit
$R_{\theta JC}$	Thermal Resistance-Junction to Case	1.46	°C/W
$R_{\theta JA}$ ③	Thermal Resistance-Junction to Ambient	30	°C/W
Drain-Source Avalanche Ratings			
E_{AS} ④	Avalanche Energy, Single Pulsed	56	mJ

Electrical Characteristics ($T_C=25^\circ\text{C}$ Unless Otherwise Noted)

Symbol	Parameter	Test Condition	KS23028NA			Unit
			Min.	Typ.	Max.	
Static Characteristics						
BV_{DSS}	Drain-Source Breakdown Voltage	$V_{GS}=0V, I_{DS}=-250\mu A$	-20			V
I_{DSS}	Zero Gate Voltage Drain Current	$V_{DS}=-20V, V_{GS}=0V$			-1	μA
		$T_J=125^\circ\text{C}$			-30	
$V_{GS(th)}$	Gate Threshold Voltage	$V_{DS}=V_{GS}, I_{DS}=-250\mu A$	-0.4	-0.7	-1	V
I_{GSS}	Gate Leakage Current	$V_{GS}=\pm 12V, V_{DS}=0V$			± 100	nA
$R_{DS(ON)}$ ⑤	Drain-Source On-state Resistance	$V_{GS}=-4.5V, I_{DS}=-20A$		1.5	2	$m\Omega$
		$V_{GS}=-2.5V, I_{DS}=-16A$		2	2.8	$m\Omega$
		$V_{GS}=-1.8V, I_{DS}=-10A$		3.3	4.7	$m\Omega$
Diode Characteristics						
V_{SD} ⑤	Diode Forward Voltage	$I_{SD}=-20A, V_{GS}=0V$		-0.73	-1.2	V
t_{rr}	Reverse Recovery Time	$I_{SD}=-20A, dI_{SD}/dt=100A/\mu s$		43		ns
Q_{rr}	Reverse Recovery Charge			162		nC
Dynamic Characteristics ⑥						
R_G	Gate Resistance	$V_{GS}=0V, V_{DS}=0V, F=1\text{MHz}$		3		Ω
C_{iss}	Input Capacitance	$V_{GS}=0V,$ $V_{DS}=-10V,$ Frequency=1.0MHz		10130		μF
C_{oss}	Output Capacitance			1290		
C_{rss}	Reverse Transfer Capacitance			585		
$t_{d(ON)}$	Turn-on Delay Time	$V_{DD}=-10V, I_{DS}=-20A,$ $V_{GS}=-4.5V, R_G=3\Omega$		33		ns
t_r	Turn-on Rise Time			59		
$t_{d(OFF)}$	Turn-off Delay Time			128		
t_f	Turn-off Fall Time			77		
Gate Charge Characteristics ⑥						
Q_g	Total Gate Charge	$V_{DS}=-10V, V_{GS}=-4.5V,$ $I_{DS}=-20A$		82		nC
Q_{gs}	Gate-Source Charge			16		
Q_{gd}	Gate-Drain Charge			15		

Notes:

- ①Pulse width limited by safe operating area.
- ②Calculated continuous current based on maximum allowable junction temperature. The package limitation current is 50A.
- ③When mounted on 1 inch square copper board, $t \leq 10\text{sec}$.
- ④Limited by T_{Jmax} , $I_{AS} = -15\text{A}$, $L = 0.5\text{mH}$, $V_{DD} = -10\text{V}$, $R_G = 25\Omega$, Starting $T_J = 25^\circ\text{C}$, 100% tested and guaranteed.
- ⑤Pulse test; Pulse width $\leq 300\mu\text{s}$, duty cycle $\leq 2\%$.
- ⑥Guaranteed by design, not subject to production testing.

Ordering and Marking Information

Device	Package	Packaging	Quantity	Reel Size	Tape width
KS23028NA	PDFN5060	Tape&Reel	5000	13"	12mm

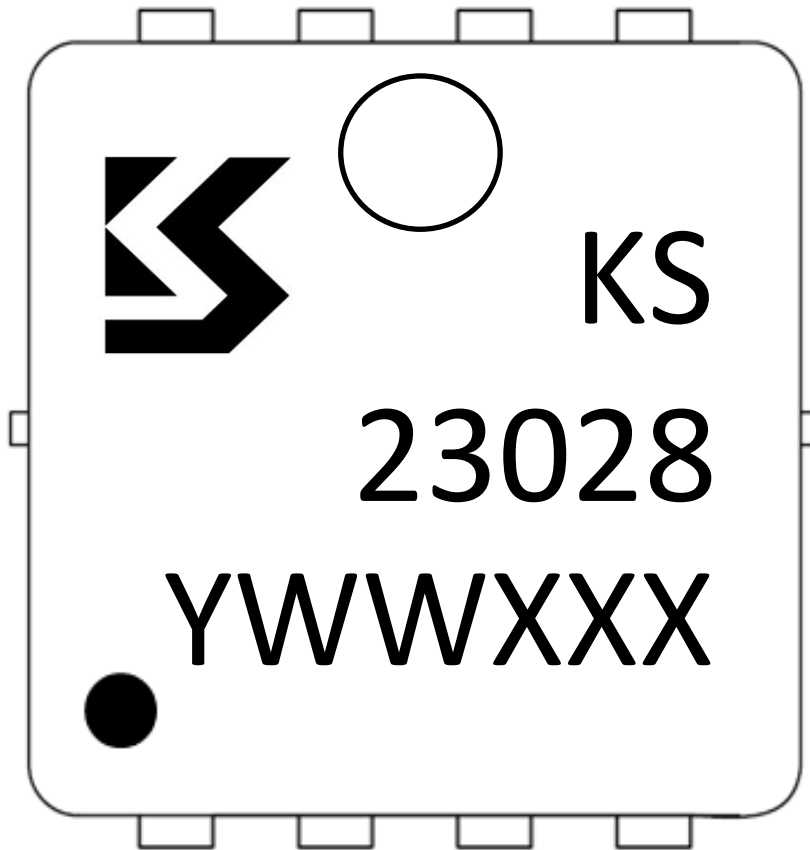

1st Line: Kwansemi LOGO, Kwansemi Code(KS)

2nd Line: Part Number(23028)

3rd Line: Lot Number(YWWXXX)

Typical Characteristics

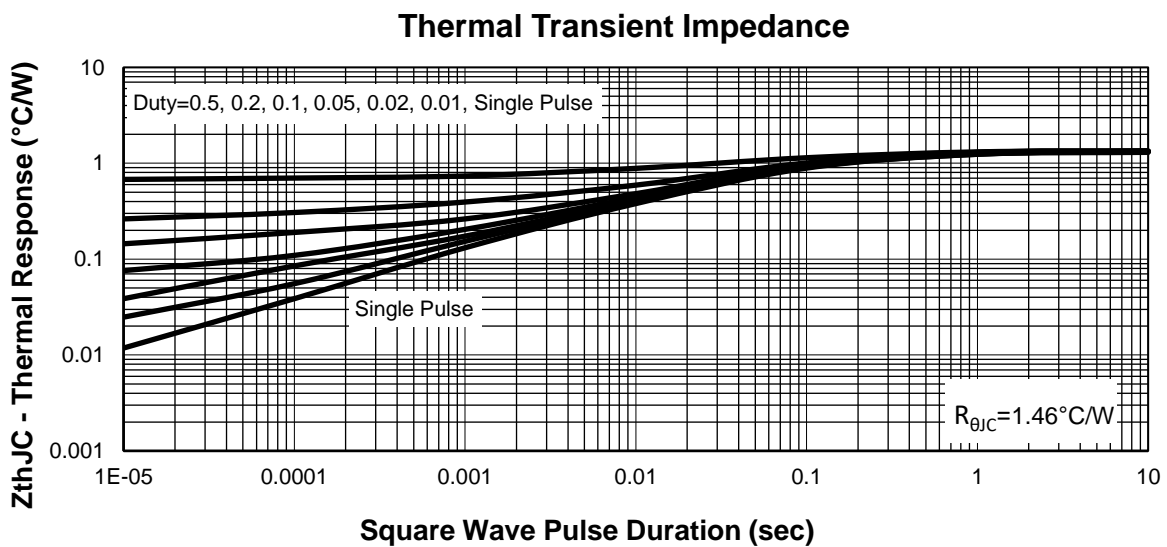
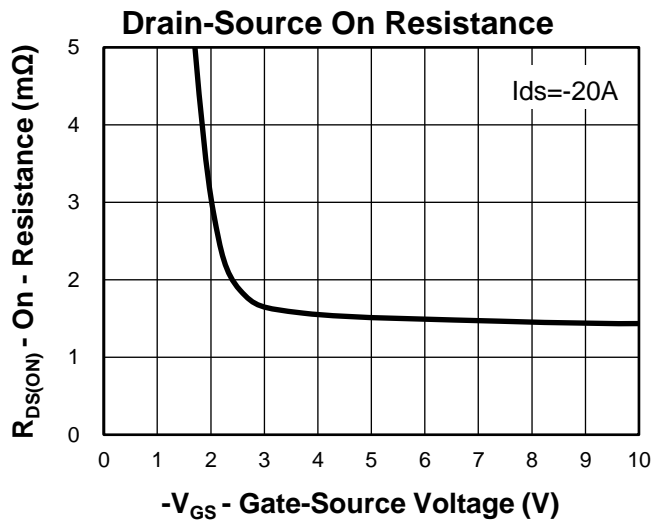
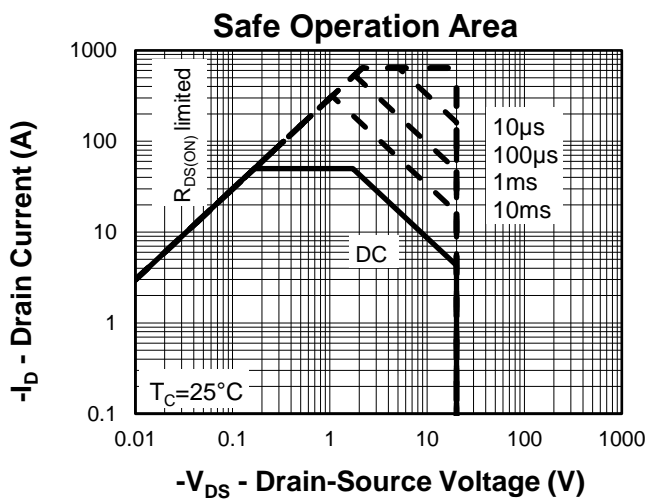
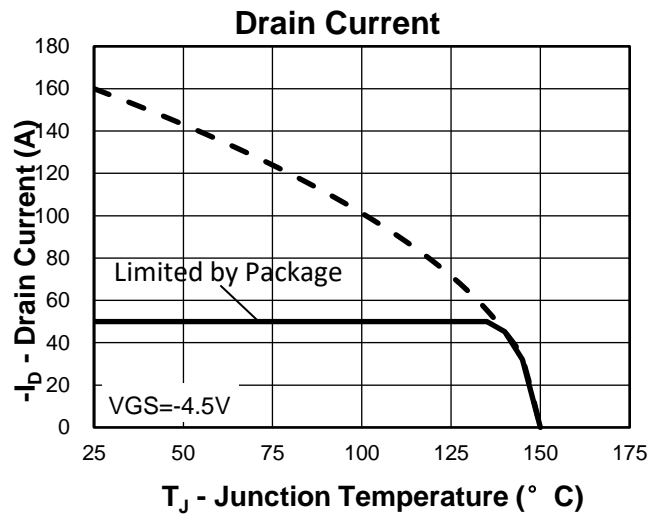
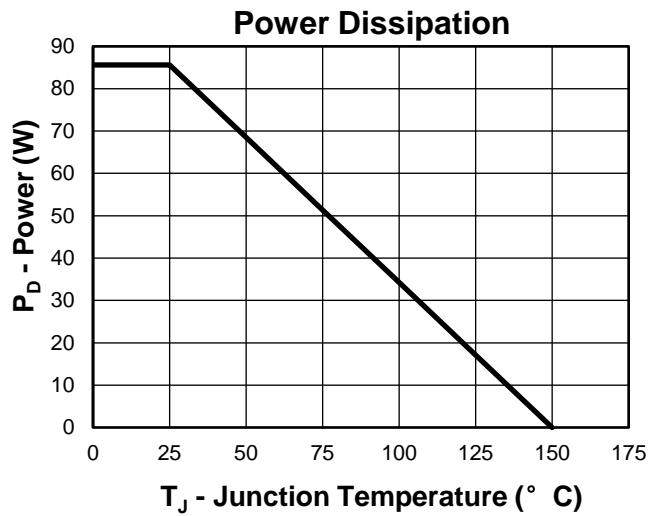

Typical Characteristics

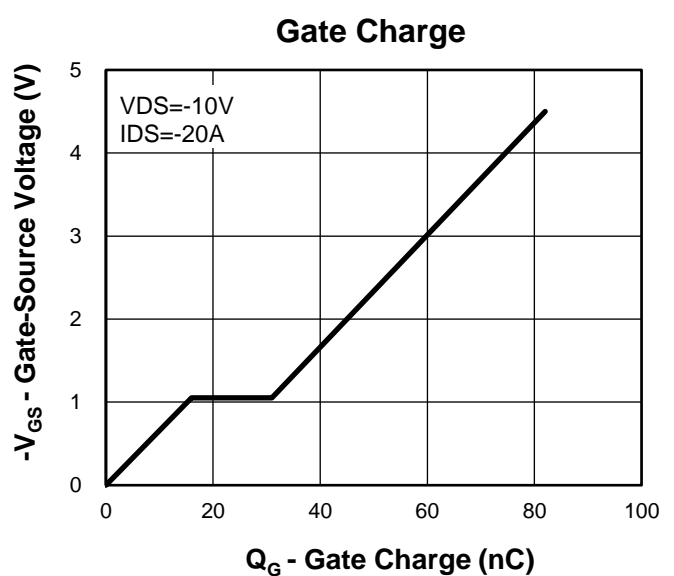
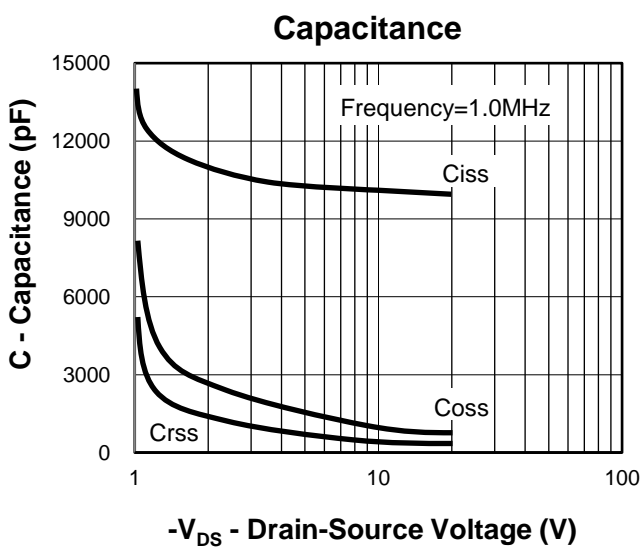
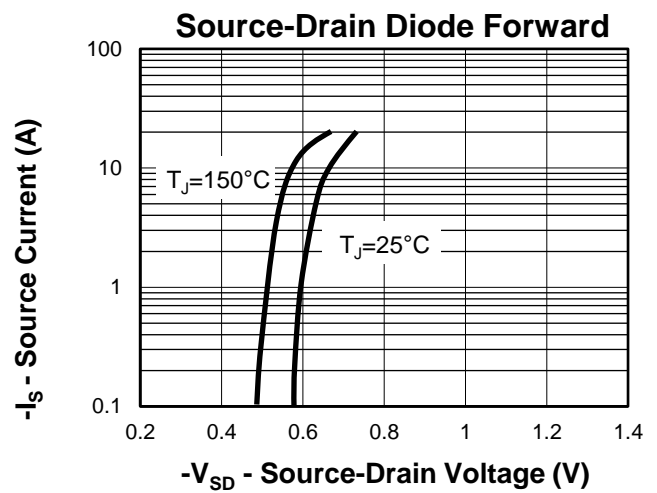
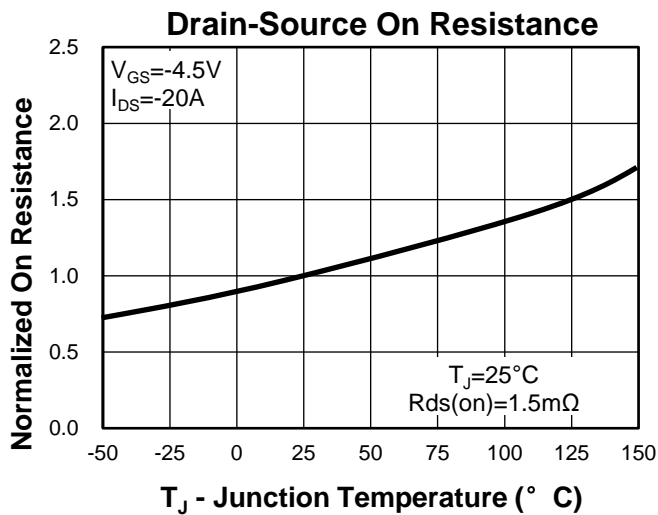
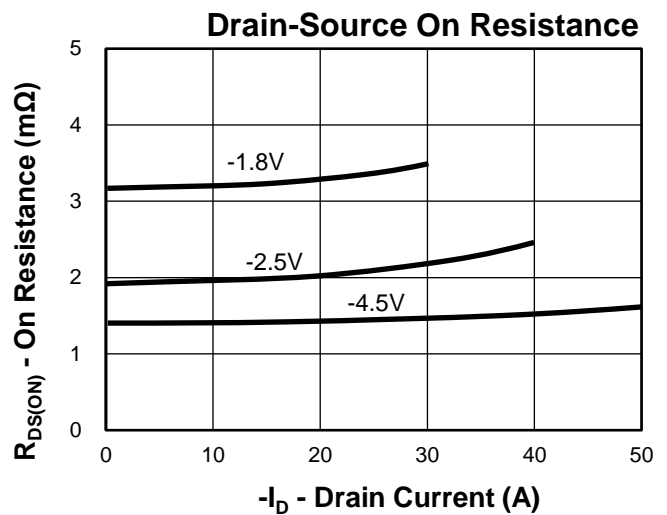
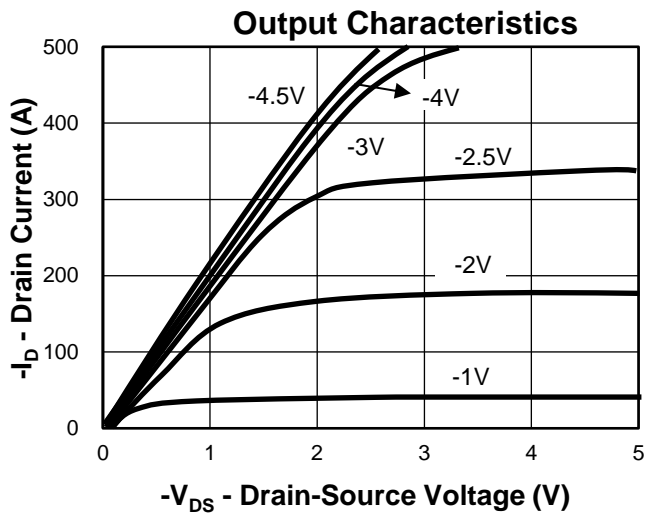

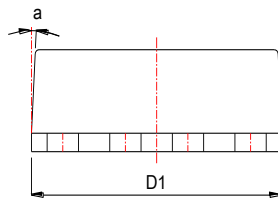
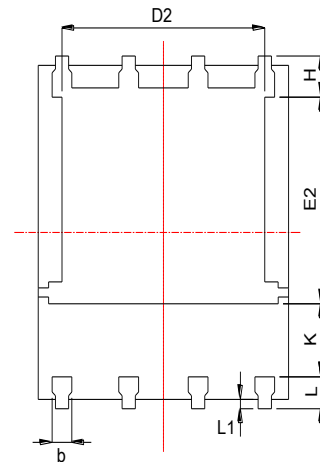
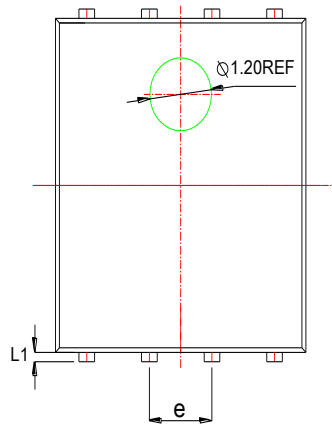
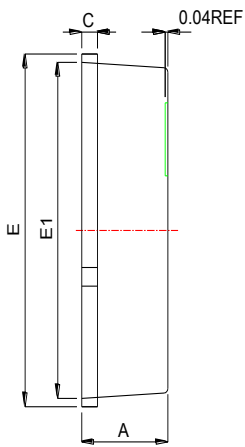
Package Information
PDFN5060

Land Pattern
(Only for Reference)

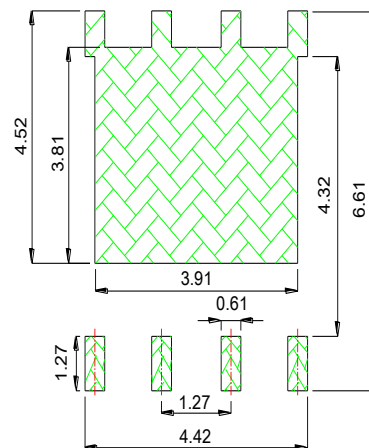

SYMBOL	MM			INCH		
	MIN	NOM	MAX	MIN	NOM	MAX
A	0.90	1.00	1.10	0.035	0.039	0.043
b	0.33	0.42	0.51	0.013	0.017	0.020
c	0.20	0.25	0.30	0.008	0.010	0.012
D1	4.80	4.90	5.00	0.189	0.193	0.197
D2	3.61	3.79	3.96	0.142	0.149	0.156
E	5.90	6.00	6.10	0.232	0.236	0.240
E1	5.65	5.75	5.85	0.222	0.226	0.230
E2	3.38	3.58	3.78	0.133	0.141	0.149
e	1.27 BSC			0.050 BSC		
H	0.41	0.51	0.61	0.016	0.020	0.024
k	1.10			0.043		
L	0.51	0.61	0.71	0.020	0.024	0.028
L1	0.06	0.13	0.20	0.002	0.005	0.008
a	0°		12°	0°		12°

Avalanche Test Circuit and Waveforms

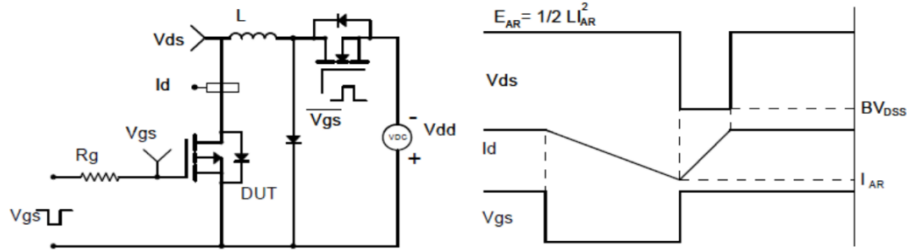

Switching Time Test Circuit and Waveforms

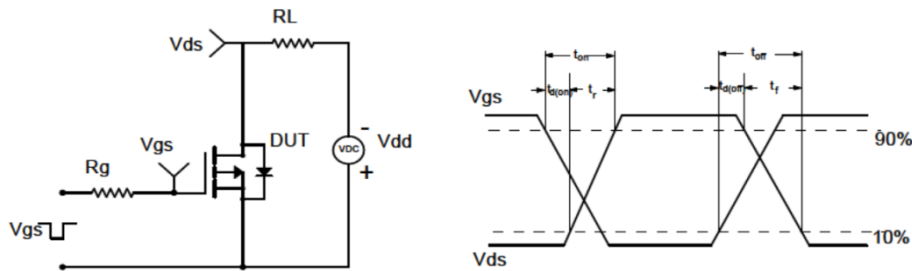

Diode Recovery Test Circuit and Waveforms

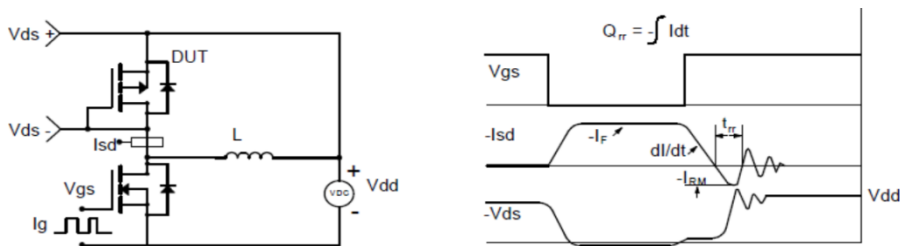

Gate Charge Test Circuit and Waveform

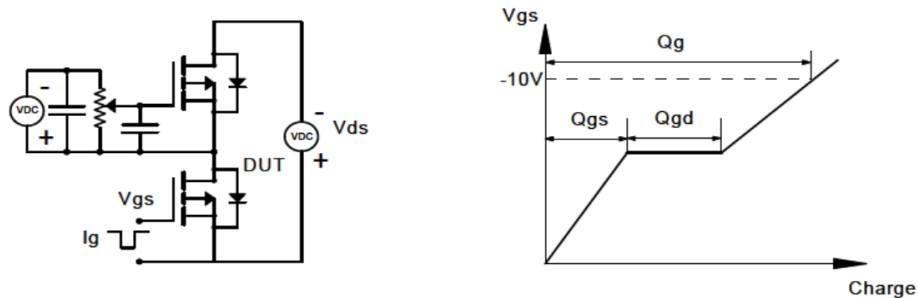

Customer Service

Kwansemi Semiconductor Co.,Ltd

Email:Sales@kwansemi.com

Web:www.kwansemi.com

DISCLAIMER:

Kwansemi reserves the right to change the specifications and circuitry without notice at any time. The Products are not designed for use in hostile environments, including, without limitation, aircraft, nuclear power generation, medical appliances, and devices or systems in which malfunction of any Product can reasonably be expected to result in a personal injury. Seller's customers using or selling Seller's products for use in such applications do so at their own risk and agree to fully defend and indemnify Seller.