

### Features

- 85V/130A,  
 $R_{DS(on)} = 3.5m\Omega(Typ.)@V_{GS}=10V$
- Excellent  $Q_G \times R_{DS(on)}$  product(FOM)
- SGT Technology
- 100% avalanche tested

### Applications

- Motor Control
- Battery Power Management



Halogen-Free

### Pin Description

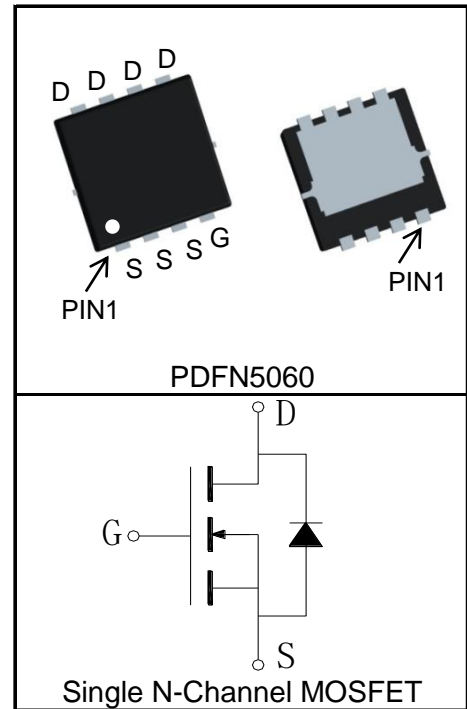

### Absolute Maximum Ratings

Symbol	Parameter	Rating	Unit	
<b>Common Ratings</b> ( $T_C=25^\circ\text{C}$ Unless Otherwise Noted)				
$V_{DSS}$	Drain-Source Voltage	85	V	
$V_{GSS}$	Gate-Source Voltage	$\pm 20$		
$T_J$	Maximum Junction Temperature	150	$^\circ\text{C}$	
$T_{STG}$	Storage Temperature Range	-55 to 150	$^\circ\text{C}$	
$I_S$	Diode Continuous Forward Current	$T_C=25^\circ\text{C}$	120	A
<b>Mounted on Large Heat Sink</b>				
$I_{DP}^{①}$	300 $\mu\text{s}$ Pulse Drain Current Tested	$T_C=25^\circ\text{C}$	480	A
$I_D^{②}$	Continuous Drain Current@ $T_C(V_{GS}=10V)$	$T_C=25^\circ\text{C}$	130	A
		$T_C=100^\circ\text{C}$	82	
	Continuous Drain Current@ $T_A(V_{GS}=10V)^{③}$	$T_A=25^\circ\text{C}$	23	
		$T_A=70^\circ\text{C}$	18	
$P_D$	Maximum Power Dissipation@ $T_C$	$T_C=25^\circ\text{C}$	119	W
		$T_C=100^\circ\text{C}$	48	
	Maximum Power Dissipation@ $T_A^{③}$	$T_A=25^\circ\text{C}$	4.2	
		$T_A=70^\circ\text{C}$	2.7	

Symbol	Parameter	Rating	Unit
$R_{\theta JC}$	Thermal Resistance-Junction to Case	1.05	°C/W
$R_{\theta JA}$ <sup>③</sup>	Thermal Resistance-Junction to Ambient	30	°C/W
<b>Drain-Source Avalanche Ratings</b>			
$E_{AS}$ <sup>④</sup>	Avalanche Energy, Single Pulsed	182	mJ

**Electrical Characteristics** ( $T_C=25^\circ\text{C}$  Unless Otherwise Noted)

Symbol	Parameter	Test Condition	KS92025NAT			Unit
			Min.	Typ.	Max.	
<b>Static Characteristics</b>						
$BV_{DSS}$	Drain-Source Breakdown Voltage	$V_{GS}=0V, I_{DS}=250\mu A$	85	92		V
$I_{DSS}$	Zero Gate Voltage Drain Current	$V_{DS}=80V, V_{GS}=0V$			1	$\mu A$
		$T_J=125^\circ C$			30	
$V_{GS(th)}$	Gate Threshold Voltage	$V_{DS}=V_{GS}, I_{DS}=250\mu A$	2	3	4	V
$I_{GSS}$	Gate Leakage Current	$V_{GS}=\pm 20V, V_{DS}=0V$			$\pm 100$	nA
$R_{DS(ON)}$ <sup>⑤</sup>	Drain-Source On-state Resistance	$V_{GS}=10V, I_{DS}=20A$		3.5	4.2	m $\Omega$
<b>Diode Characteristics</b>						
$V_{SD}$ <sup>⑤</sup>	Diode Forward Voltage	$I_{SD}=20A, V_{GS}=0V$		0.8	1.2	V
$t_{rr}$	Reverse Recovery Time	$I_{SD}=20A, dI_{SD}/dt=100A/\mu s$		31		ns
$Q_{rr}$	Reverse Recovery Charge			48		nC
<b>Dynamic Characteristics</b> <sup>⑥</sup>						
$R_G$	Gate Resistance	$V_{GS}=0V, V_{DS}=0V, F=1MHz$		1.8		$\Omega$
$C_{iss}$	Input Capacitance	$V_{GS}=0V,$ $V_{DS}=40V,$ Frequency=1.0MHz		2950		pF
$C_{oss}$	Output Capacitance			1100		
$C_{rss}$	Reverse Transfer Capacitance			55		
$t_{d(ON)}$	Turn-on Delay Time		$V_{DD}=40V, I_{DS}=20A,$ $V_{GS}=10V, R_G=3\Omega$		14	
$t_r$	Turn-on Rise Time			21		
$t_{d(OFF)}$	Turn-off Delay Time			29		
$t_f$	Turn-off Fall Time			10		
<b>Gate Charge Characteristics</b> <sup>⑥</sup>						
$Q_g$	Total Gate Charge	$V_{DS}=40V, V_{GS}=10V,$ $I_{DS}=20A$		44		nC
$Q_{gs}$	Gate-Source Charge			10		
$Q_{gd}$	Gate-Drain Charge			8		

**Notes:**

- ①Pulse width limited by safe operating area.
- ②Calculated continuous current based on maximum allowable junction temperature. The package limitation current is 50A.
- ③When mounted on 1 inch square copper board,  $t \leq 10\text{sec}$ .
- ④Limited by  $T_{J\text{max}}$ ,  $I_{AS} = 27\text{A}$ ,  $L = 0.5\text{mH}$ ,  $V_{DD} = 48\text{V}$ ,  $R_G = 25\Omega$ , Starting  $T_J = 25^\circ\text{C}$ , 100% tested and guaranteed.
- ⑤Pulse test; Pulse width  $\leq 300\mu\text{s}$ , duty cycle  $\leq 2\%$ .
- ⑥Guaranteed by design, not subject to production testing.

**Ordering and Marking Information**

Device	Package	Packaging	Quantity	Reel Size	Tape width
KS92025NAT	PDFN5060	Tape&Reel	5000	13"	12mm

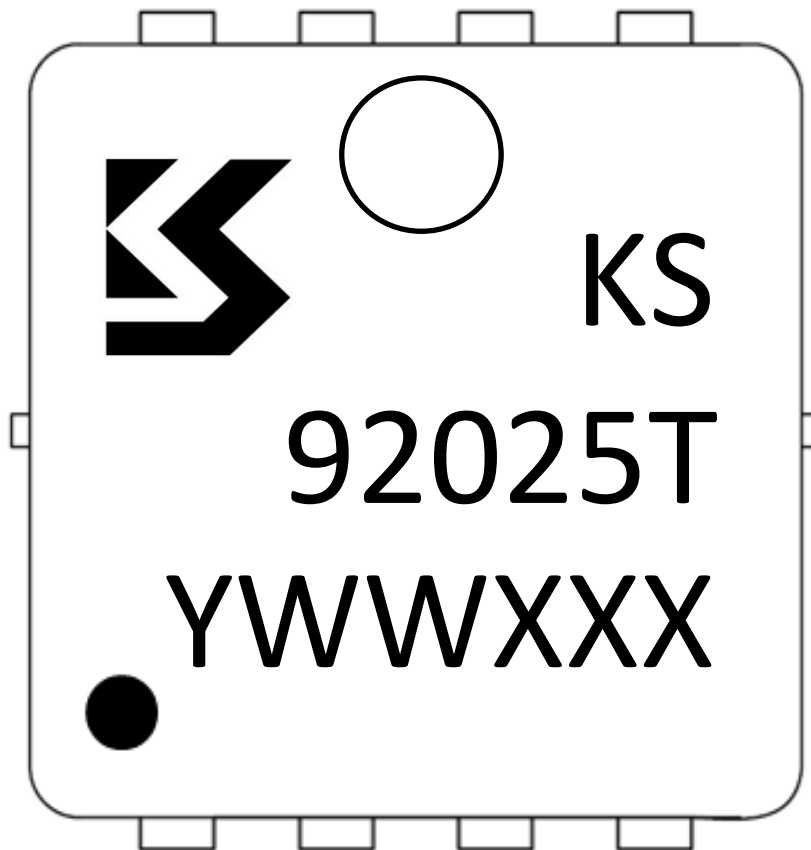

1st Line: Kwansemi LOGO, Kwansemi Code(KS)

2nd Line: Part Number(92025T)

3rd Line: Lot Number(YWWXXX)

### Typical Characteristics

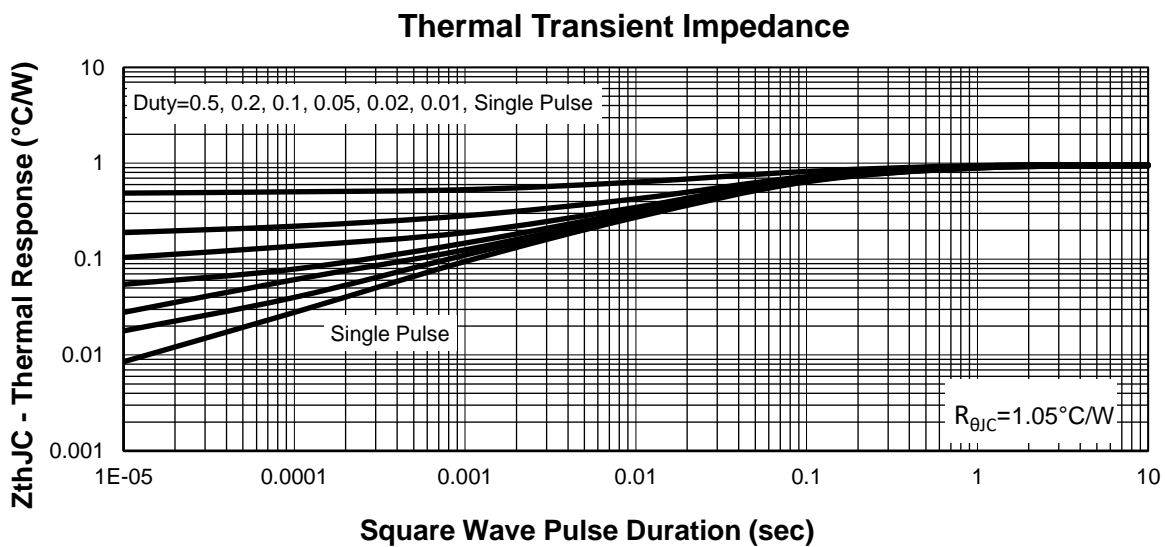
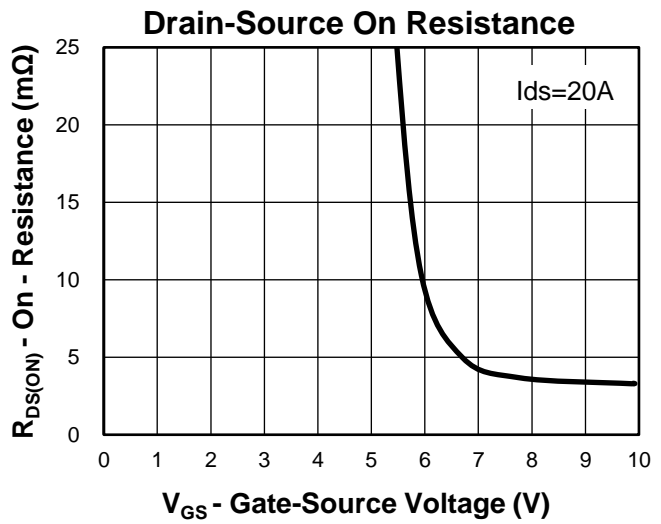
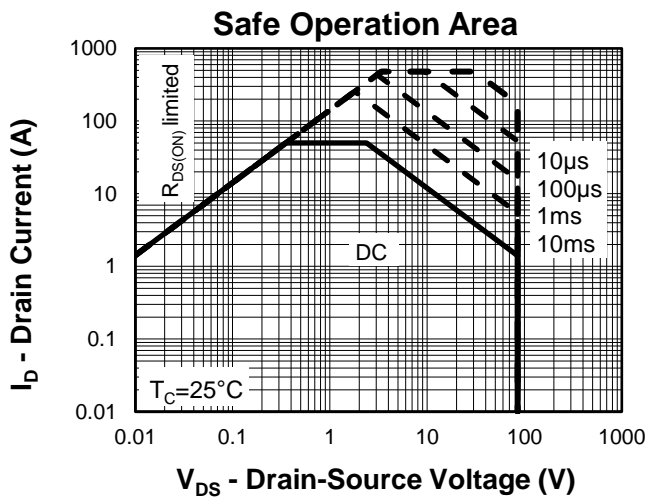
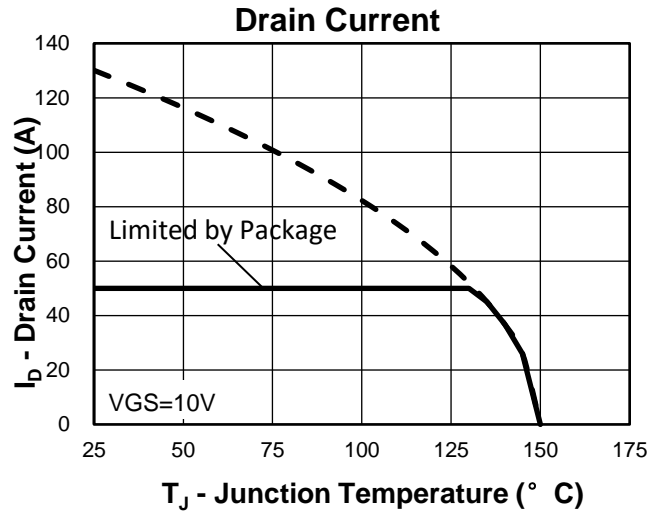
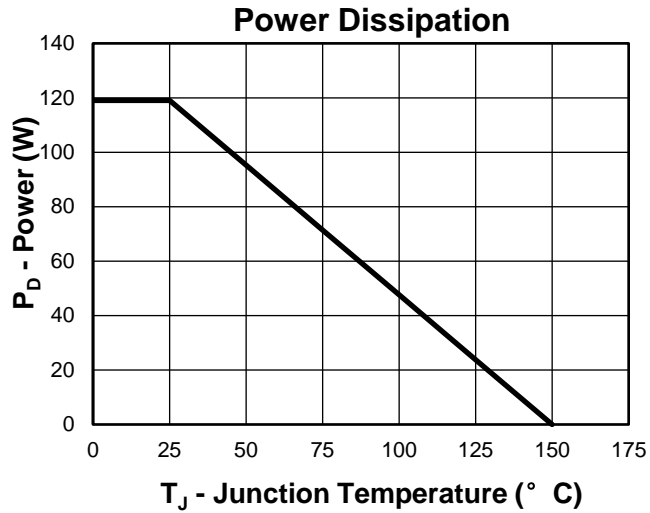

### Typical Characteristics

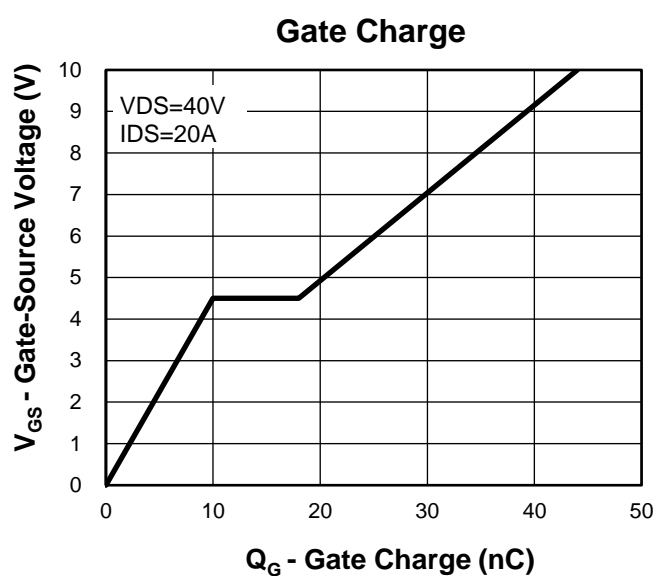
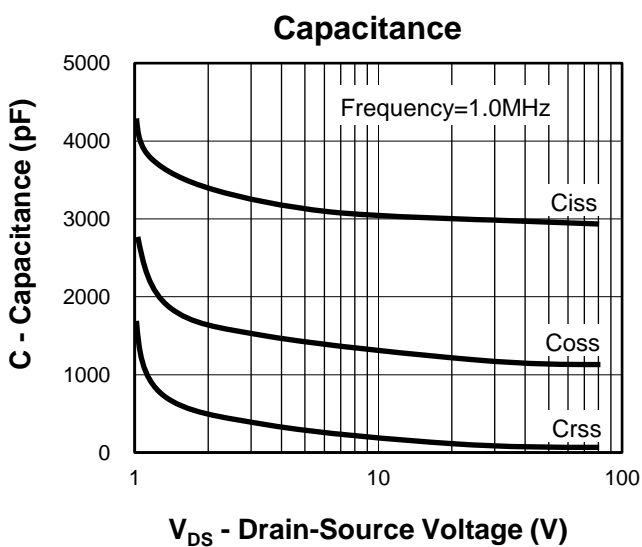
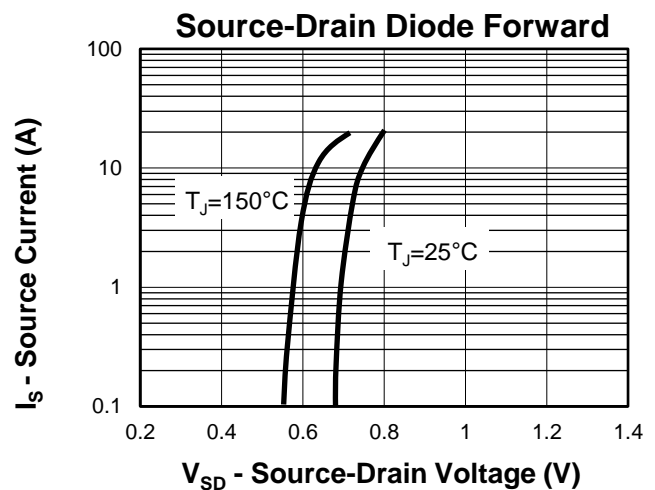
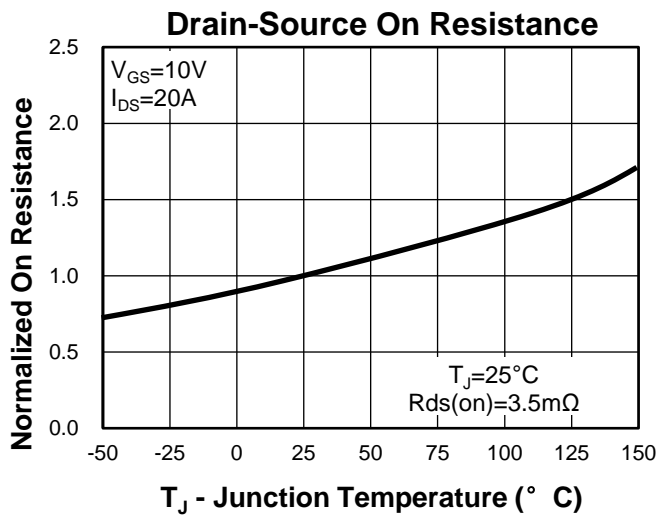
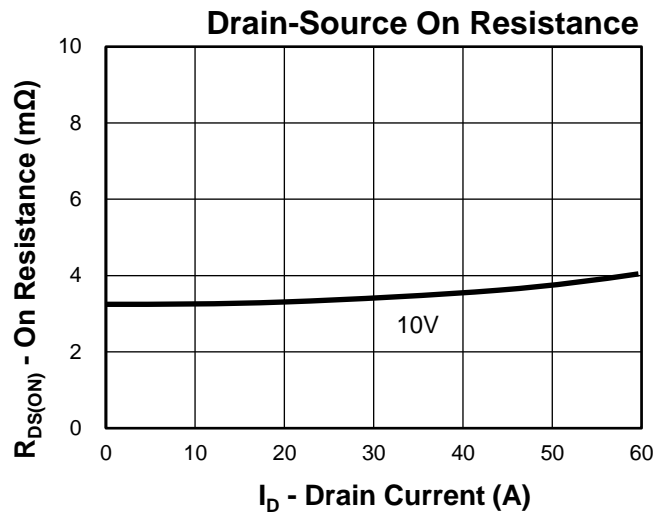
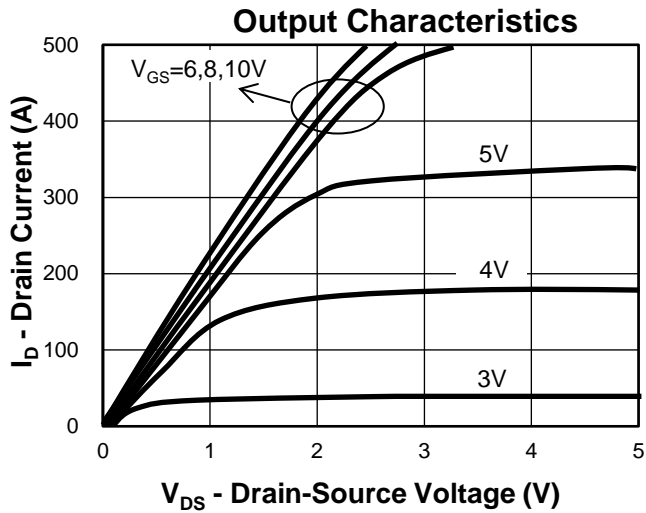

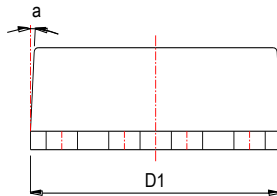
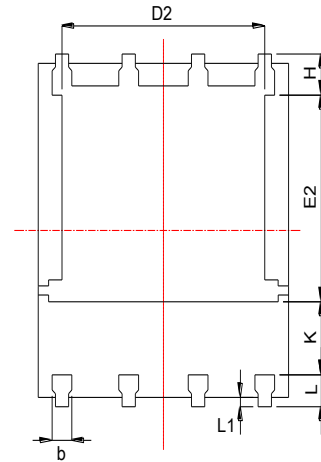
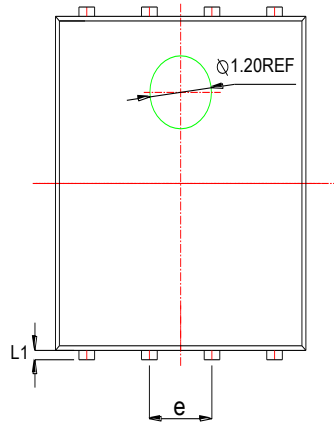
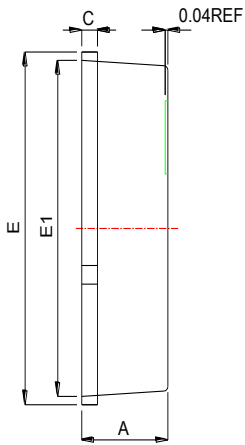
**Package Information**
**PDFN5060**

Land Pattern  
(Only for Reference)

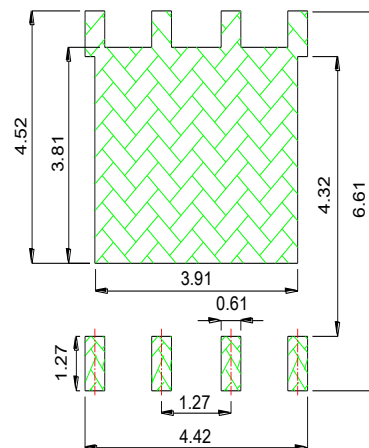

SYMBOL	MM			INCH		
	MIN	NOM	MAX	MIN	NOM	MAX
A	0.90	1.00	1.10	0.035	0.039	0.043
b	0.33	0.42	0.51	0.013	0.017	0.020
c	0.20	0.25	0.30	0.008	0.010	0.012
D1	4.80	4.90	5.00	0.189	0.193	0.197
D2	3.61	3.79	3.96	0.142	0.149	0.156
E	5.90	6.00	6.10	0.232	0.236	0.240
E1	5.65	5.75	5.85	0.222	0.226	0.230
E2	3.38	3.58	3.78	0.133	0.141	0.149
e	1.27 BSC			0.050 BSC		
H	0.41	0.51	0.61	0.016	0.020	0.024
k	1.10			0.043		
L	0.51	0.61	0.71	0.020	0.024	0.028
L1	0.06	0.13	0.20	0.002	0.005	0.008
a	0°		12°	0°		12°

### Avalanche Test Circuit and Waveforms



### Switching Time Test Circuit and Waveforms



### Diode Recovery Test Circuit and Waveforms



### Gate Charge Test Circuit and Waveform



### Customer Service

Kwansemi Semiconductor Co.,Ltd

Email:Sales@kwansemi.com

Web:www.kwansemi.com

### DISCLAIMER:

Kwansemi reserves the right to change the specifications and circuitry without notice at any time. The Products are not designed for use in hostile environments, including, without limitation, aircraft, nuclear power generation, medical appliances, and devices or systems in which malfunction of any Product can reasonably be expected to result in a personal injury. Seller's customers using or selling Seller's products for use in such applications do so at their own risk and agree to fully defend and indemnify Seller.