

Features

- 60V/195A,
 $R_{DS(ON)} = 2.4m\Omega(Typ.)@V_{GS}=10V$
 $R_{DS(ON)} = 2.9m\Omega(Typ.)@V_{GS}=4.5V$
- Excellent $Q_G \times R_{DS(on)}$ product(FOM)
- SGT Technology
- 100% Avalanche Tested

Applications

- DC-DC Converters
- High Frequency Switching and Synchronous Rectification



Halogen-Free

Pin Description

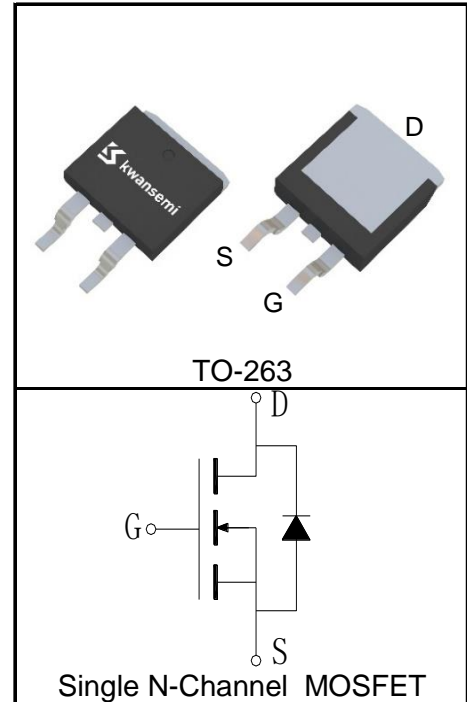

Absolute Maximum Ratings

Symbol	Parameter	Rating	Unit
Common Ratings ($T_C=25^\circ\text{C}$ Unless Otherwise Noted)			
V_{DSS}	Drain-Source Voltage	60	V
V_{GSS}	Gate-Source Voltage	± 20	
T_{Jmax}	Maximum Junction Temperature	175	$^\circ\text{C}$
T_J, T_{STG}	Operating and Storage Temperature Range	-55 to 175	$^\circ\text{C}$
I_S	Diode Continuous Forward Current	$T_C=25^\circ\text{C}$ 195	A
Mounted on Large Heat Sink			
$I_{DP}^{①}$	Pulse Drain Current	$T_C=25^\circ\text{C}$ 780	A
$I_D^{②}$	Continuous Drain Current($V_{GS}=10V$)	$T_C=25^\circ\text{C}$ 195	A
		$T_C=100^\circ\text{C}$ 138	
P_D	Maximum Power Dissipation	$T_C=25^\circ\text{C}$ 200	W
		$T_C=100^\circ\text{C}$ 100	
$R_{\theta JC}$	Thermal Resistance-Junction to Case	0.75	$^\circ\text{C}/\text{W}$
$R_{\theta JA}^{③}$	Thermal Resistance-Junction to Ambient	62.5	$^\circ\text{C}/\text{W}$
Drain-Source Avalanche Ratings			
$E_{AS}^{④}$	Avalanche Energy, Single Pulsed	1056	mJ

Electrical Characteristics ($T_C=25^\circ\text{C}$ Unless Otherwise Noted)

Symbol	Parameter	Test Condition	KS62024GAT			Unit
			Min.	Typ.	Max.	
Static Characteristics						
BV_{DSS}	Drain-Source Breakdown Voltage	$V_{GS}=0V, I_{DS}=250\mu A$	60			V
I_{DSS}	Zero Gate Voltage Drain Current	$V_{DS}=60V, V_{GS}=0V$			1	μA
		$T_J=125^\circ\text{C}$			30	
$V_{GS(th)}$	Gate Threshold Voltage	$V_{DS}=V_{GS}, I_{DS}=250\mu A$	1.1	1.7	2.3	V
I_{GSS}	Gate Leakage Current	$V_{GS}=\pm 20V, V_{DS}=0V$			± 100	nA
$R_{DS(ON)}^{(5)}$	Drain-Source On-state Resistance	$V_{GS}=10V, I_{DS}=40A$		2.4	2.9	$m\Omega$
		$V_{GS}=4.5V, I_{DS}=30A$		2.9	3.8	$m\Omega$
Diode Characteristics						
$V_{SD}^{(5)}$	Diode Forward Voltage	$I_{SD}=40A, V_{GS}=0V$		0.85	1.2	V
t_{rr}	Reverse Recovery Time	$I_{SD}=40A, dI_{SD}/dt=100A/\mu s$		67		ns
Q_{rr}	Reverse Recovery Charge			54		nC
Dynamic Characteristics⁽⁶⁾						
R_G	Gate Resistance	$V_{GS}=0V, V_{DS}=0V, F=1\text{MHz}$		2.2		Ω
C_{iss}	Input Capacitance	$V_{GS}=0V,$ $V_{DS}=30V,$ Frequency=200KHz		5390		pF
C_{oss}	Output Capacitance			1045		
C_{riss}	Reverse Transfer Capacitance			25		
$t_{d(ON)}$	Turn-on Delay Time	$V_{DD}=30V, I_{DS}=40A,$ $V_{GEN}=10V, R_G=3\Omega$		16		ns
t_r	Turn-on Rise Time			49		
$t_{d(OFF)}$	Turn-off Delay Time			31		
t_f	Turn-off Fall Time			29		
Gate Charge Characteristics⁽⁶⁾						
Q_g	Total Gate Charge	$V_{DS}=30V, V_{GS}=10V,$ $I_{DS}=40A$		80		nC
Q_{gs}	Gate-Source Charge			16		
Q_{gd}	Gate-Drain Charge			11		

- Notes:
- ① Pulse width limited by safe operating area.
 - ② Calculated continuous current based on maximum allowable junction temperature. The package limitation current is 75A.
 - ③ When mounted on 1 inch square copper board, $t \leq 10\text{sec}$. The value in any given application depends on the user's specific board design.
 - ④ Limited by T_{Jmax} , Starting $T_J = 25^\circ\text{C}$, $I_{ASmax} = 65A$, $L = 0.5\text{mH}$, $V_{DD} = 48V$, $R_G = 25\Omega$, $V_{GS} = 10V$. Part not recommended for use above this value. 100% Final Test at $I_{AS} = 46A$, $L = 0.5\text{mH}$.
 - ⑤ Pulse test; Pulse width $\leq 300\mu s$, duty cycle $\leq 2\%$.
 - ⑥ Guaranteed by design, not subject to production testing.

Ordering and Marking Information

Device	Package	Packaging	Quantity	Reel Size	Tape width
KS62024GAT	TO-263	Tape&Reel	800	13"	24mm

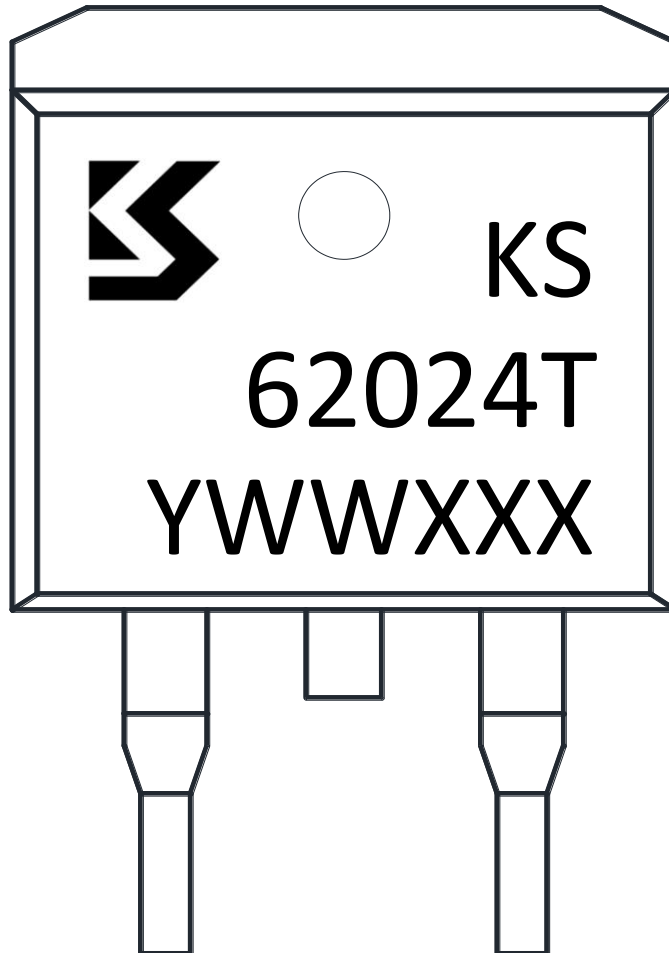

1st Line: Kwansemi LOGO, Kwansemi Code(KS)

2nd Line: Part Number(62024T)

3rd Line: Lot Number(YWWXXX)

Typical Characteristics

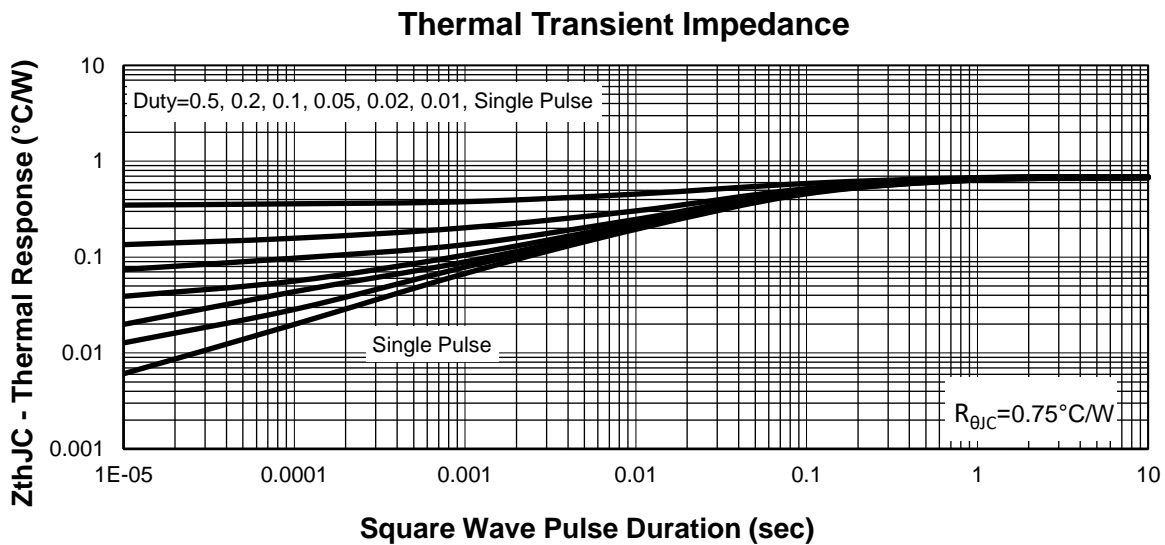
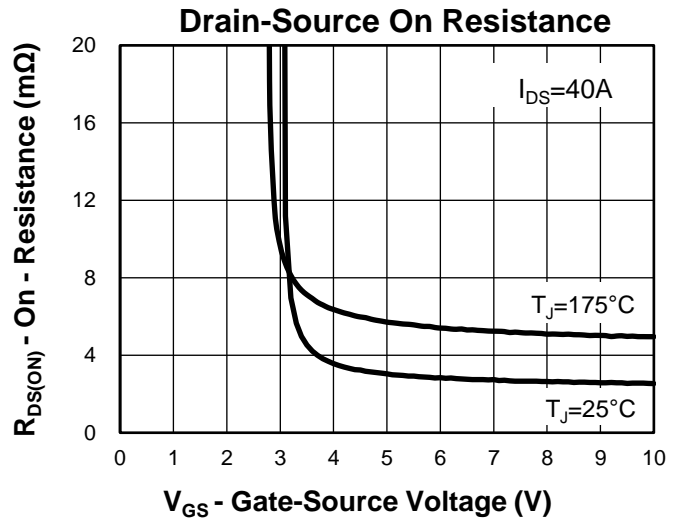
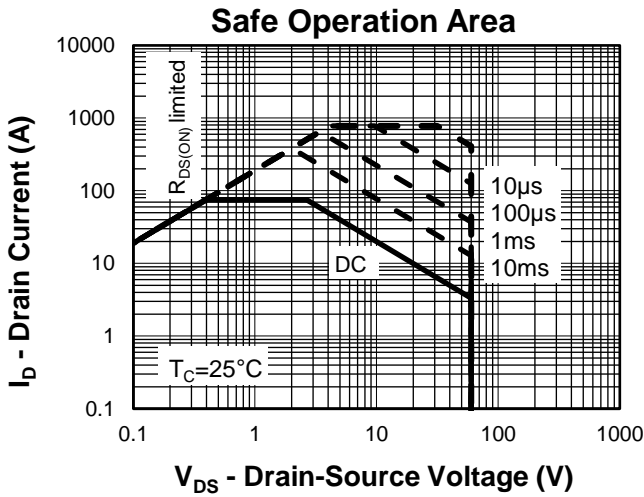
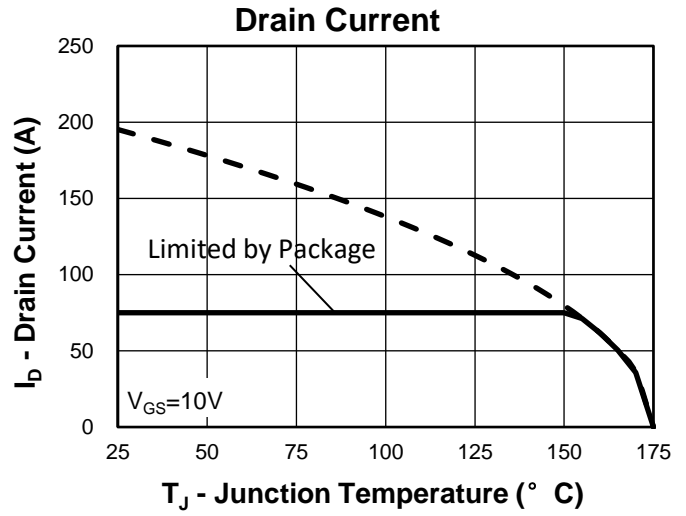
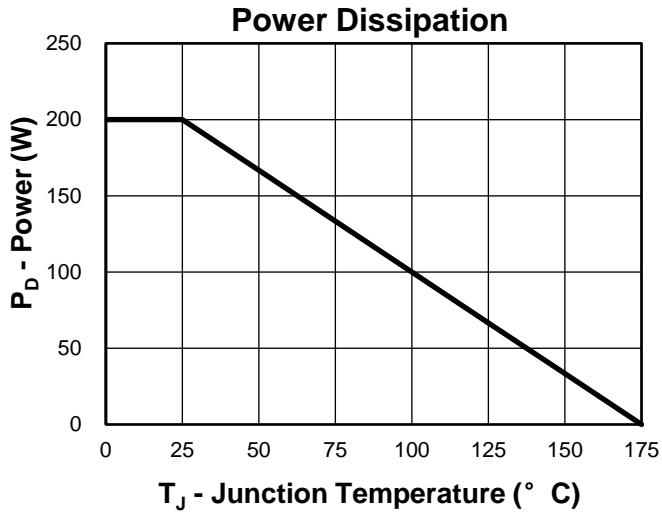

Typical Characteristics

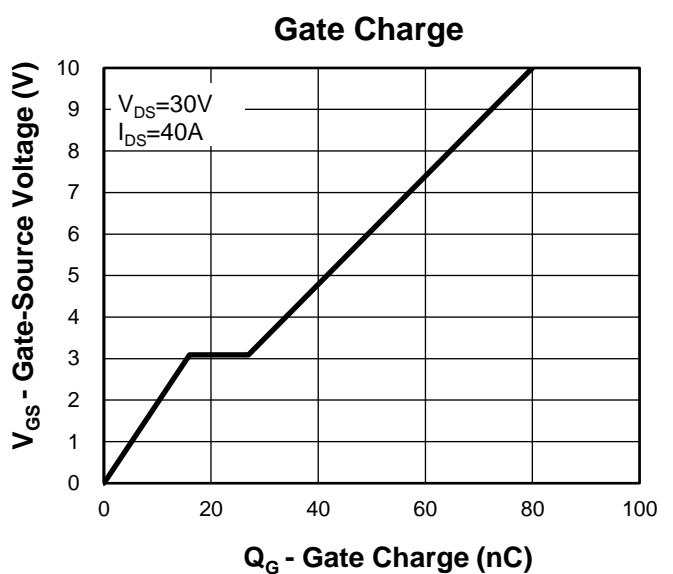
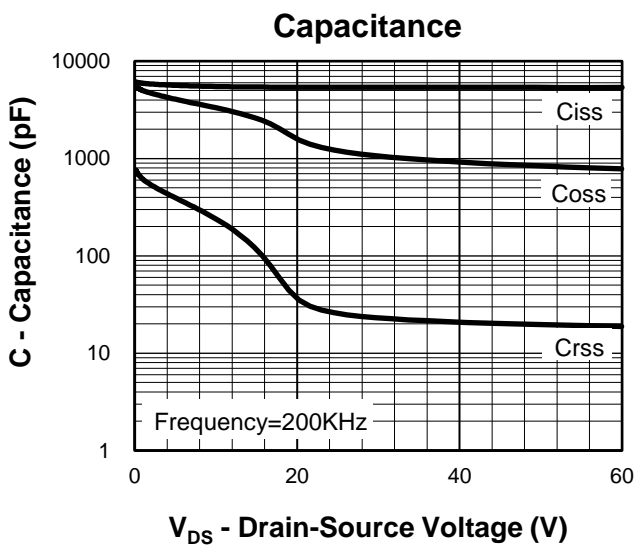
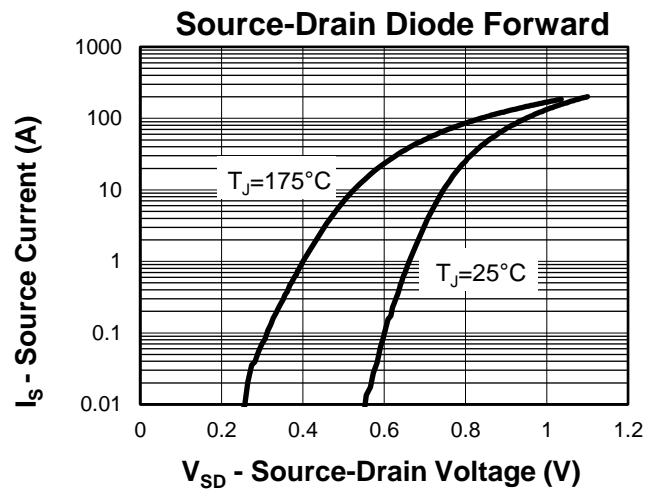
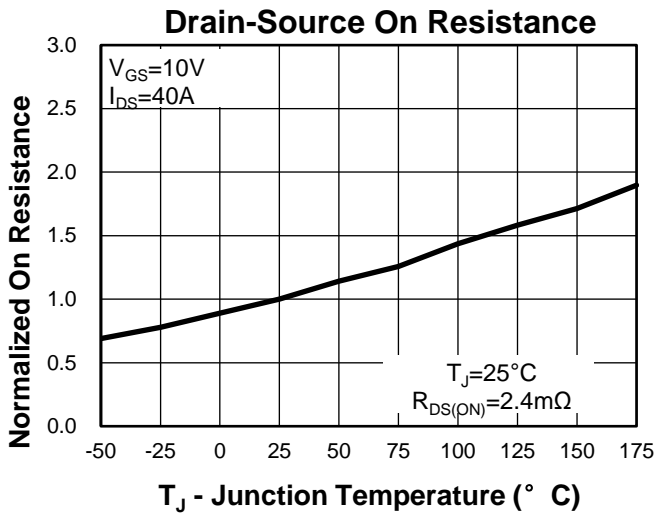
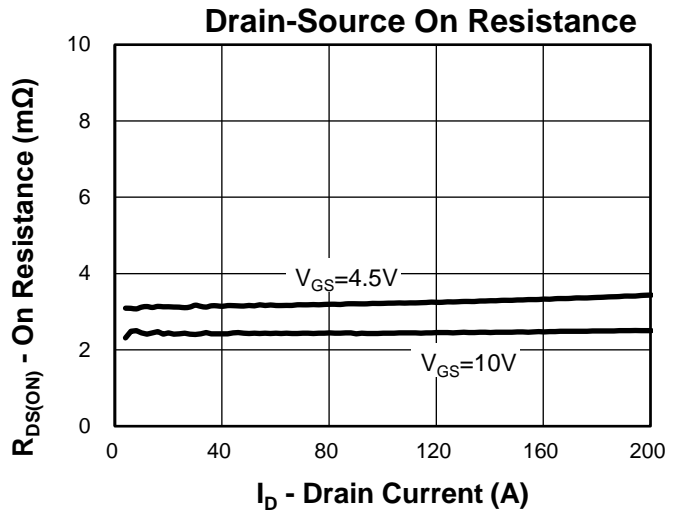
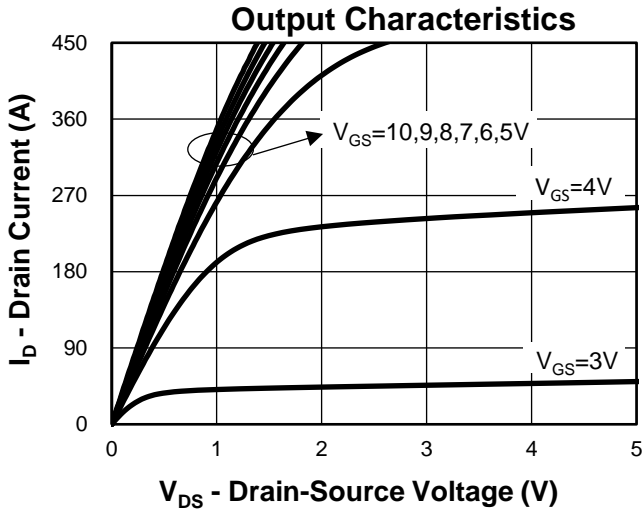

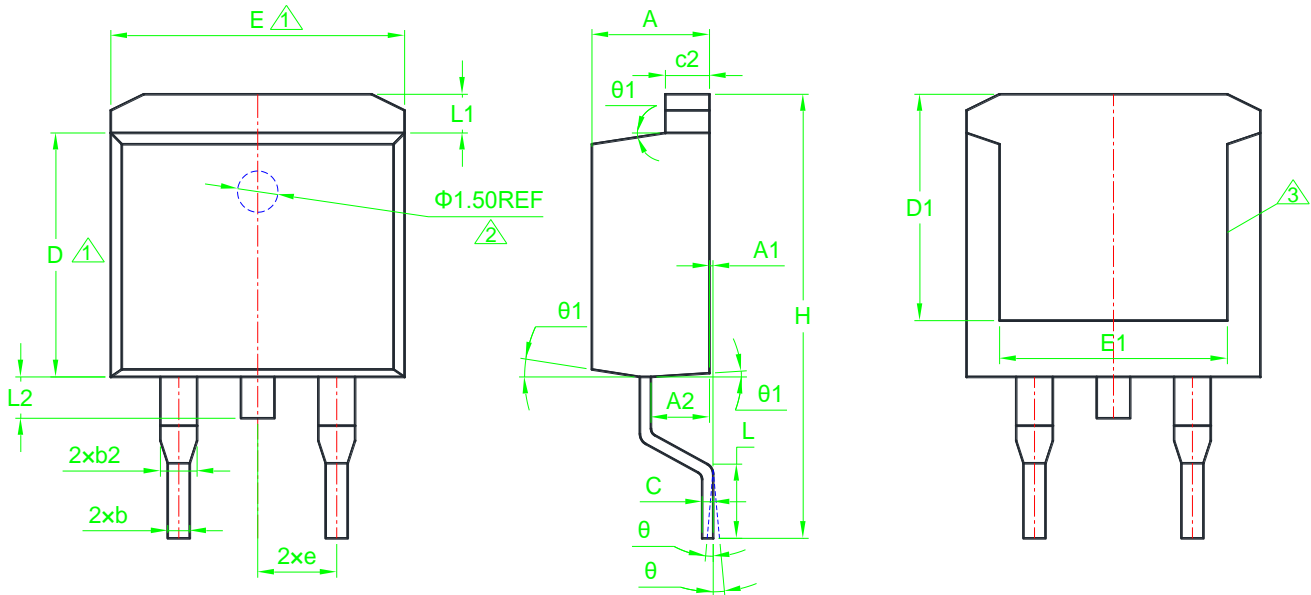
Package Information
TO-263

SYMBOL	MM			INCH			SYMBOL	MM			INCH		
	MIN	NOM	MAX	MIN	NOM	MAX		MIN	NOM	MAX	MIN	NOM	MAX
A	4.30	4.50	4.80	0.169	0.177	0.189	e	2.54BSC			0.100BSC		
A1	0.00	0.10	0.25	0.000	0.004	0.010	E	9.90	10.10	10.30	0.390	0.398	0.406
A2	2.20	*	2.80	0.087	*	0.110	E1	7.00	*	8.50	0.276	*	0.335
b	0.70	0.85	0.95	0.028	0.033	0.037	H	14.80	*	15.70	0.583	*	0.618
b2	1.15	*	1.47	0.045	*	0.058	L	2.10	*	2.79	0.083	*	0.110
c	0.38	*	0.65	0.015	*	0.026	L1	1.10	*	1.42	0.043	*	0.056
c2	1.20	1.30	1.40	0.047	0.051	0.055	L2	1.00	*	1.70	0.039	*	0.067
D	8.40	8.90	9.40	0.331	0.350	0.370	θ	0°	*	8°	0°	*	8°
D1	7.10	*	8.20	0.280	*	0.323	θ 1	3°	*	9°	3°	*	9°

- ① Dimensions D and E do not include mold flash protrusions or gate burrs.
- ② The existence and size of demolding hole are variable depending on mold.
- ③ The size and shape of exposed pad are variable depending on mold.

Avalanche Test Circuit and Waveforms

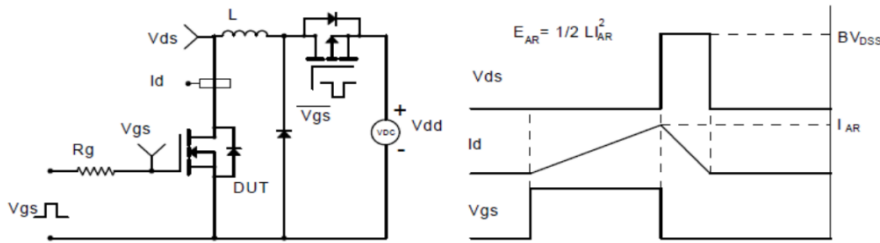

Switching Time Test Circuit and Waveforms



Diode Recovery Test Circuit and Waveforms

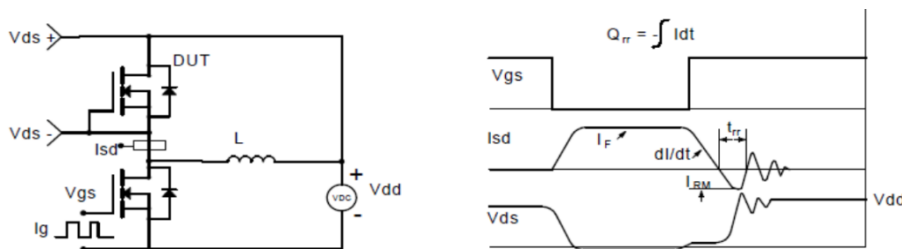

Gate Charge Test Circuit and Waveform



Customer Service

Kwansemi Semiconductor Co.,Ltd

Email:Sales@kwansemi.com

Web:www.kwansemi.com

DISCLAIMER:

Kwansemi reserves the right to change the specifications and circuitry without notice at any time. The Products are not designed for use in hostile environments, including, without limitation, aircraft, nuclear power generation, medical appliances, and devices or systems in which malfunction of any Product can reasonably be expected to result in a personal injury. Seller's customers using or selling Seller's products for use in such applications do so at their own risk and agree to fully defend and indemnify Seller.