

## Features

- -20V/-5.2A,  
 $R_{DS(ON)} = 21m\Omega(Typ.)@V_{GS}=-4.5V$   
 $R_{DS(ON)} = 27m\Omega(Typ.)@V_{GS}=-2.5V$   
 $R_{DS(ON)} = 37m\Omega(Typ.)@V_{GS}=-1.8V$
- Super High Dense Cell Design
- Reliable and Rugged

## Applications

- Load Switch



Halogen-Free

## Pin Description

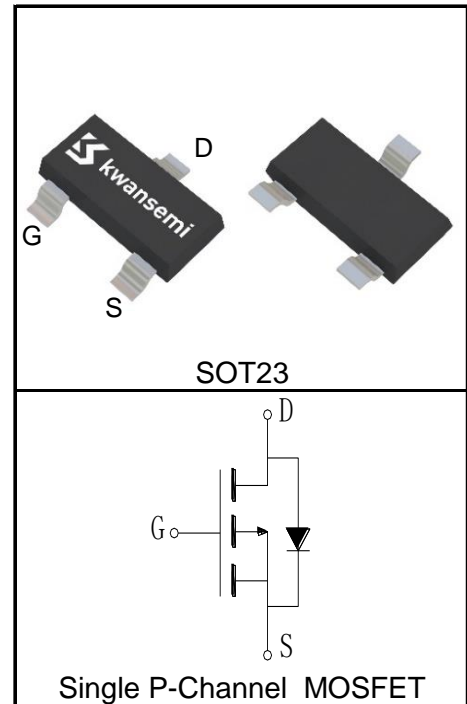

## Absolute Maximum Ratings

Symbol	Parameter	Rating	Unit
<b>Common Ratings</b> ( $T_A=25^\circ\text{C}$ Unless Otherwise Noted)			
$V_{DSS}$	Drain-Source Voltage	-20	V
$V_{GSS}$	Gate-Source Voltage	$\pm 12$	
$T_{Jmax}$	Maximum Junction Temperature	150	$^\circ\text{C}$
$T_J, T_{STG}$	Operating and Storage Temperature Range	-55 to 150	$^\circ\text{C}$
$I_S$	Diode Continuous Forward Current	$T_A=25^\circ\text{C}$ -1.2	A
<b>Mounted on Large Heat Sink</b>			
$I_{DP}^{(1)}$	Pulse Drain Current	$T_A=25^\circ\text{C}$ -20	A
$I_D^{(2)}$	Continuous Drain Current ( $V_{GS}=-4.5V$ )	$T_A=25^\circ\text{C}$ -5.2	A
		$T_A=70^\circ\text{C}$ -4.1	
$P_D$	Maximum Power Dissipation	$T_A=25^\circ\text{C}$ 1	W
		$T_A=70^\circ\text{C}$ 0.64	
$R_{\theta JL}$	Thermal Resistance-Junction to Lead	80	$^\circ\text{C}/\text{W}$
$R_{\theta JA}^{(3)}$	Thermal Resistance-Junction to Ambient	125	$^\circ\text{C}/\text{W}$
<b>Drain-Source Avalanche Ratings</b>			
$E_{AS}^{(4)}$	Avalanche Energy, Single Pulsed	30	mJ

**Electrical Characteristics** ( $T_A=25^\circ\text{C}$  Unless Otherwise Noted)

Symbol	Parameter	Test Condition	KS2335AA			Unit
			Min.	Typ.	Max.	
<b>Static Characteristics</b>						
$BV_{DSS}$	Drain-Source Breakdown Voltage	$V_{GS}=0V, I_{DS}=-250\mu A$	-20			V
$I_{DSS}$	Zero Gate Voltage Drain Current	$V_{DS}=-20V, V_{GS}=0V$			-1	$\mu A$
		$T_J=125^\circ\text{C}$			-30	
$V_{GS(th)}$	Gate Threshold Voltage	$V_{DS}=V_{GS}, I_{DS}=-250\mu A$	-0.4	-0.7	-1	V
$I_{GSS}$	Gate Leakage Current	$V_{GS}=\pm 12V, V_{DS}=0V$			$\pm 100$	nA
$R_{DS(ON)}^{(5)}$	Drain-Source On-state Resistance	$V_{GS}=-4.5V, I_{DS}=-4A$		21	25	$m\Omega$
		$V_{GS}=-2.5V, I_{DS}=-3A$		27	34	$m\Omega$
		$V_{GS}=-1.8V, I_{DS}=-2A$		37	50	$m\Omega$
<b>Diode Characteristics</b>						
$V_{SD}^{(5)}$	Diode Forward Voltage	$I_{SD}=-4A, V_{GS}=0V$		-0.82	-1.2	V
$t_{rr}$	Reverse Recovery Time	$I_{SD}=-4A, di_{SD}/dt=-100A/\mu s$		26		ns
$Q_{rr}$	Reverse Recovery Charge			14		nC
<b>Dynamic Characteristics<sup>(6)</sup></b>						
$R_G$	Gate Resistance	$V_{GS}=0V, V_{DS}=0V, F=1\text{MHz}$		12		$\Omega$
$C_{iss}$	Input Capacitance	$V_{GS}=0V,$ $V_{DS}=-10V,$ Frequency=1.0MHz		1315		pF
$C_{oss}$	Output Capacitance			160		
$C_{riss}$	Reverse Transfer Capacitance			120		
$t_{d(ON)}$	Turn-on Delay Time	$V_{DD}=-10V, I_{DS}=-4A,$ $V_{GEN}=-4.5V, R_G=6\Omega$		15		ns
$t_r$	Turn-on Rise Time			12		
$t_{d(OFF)}$	Turn-off Delay Time			51		
$t_f$	Turn-off Fall Time			22		
<b>Gate Charge Characteristics<sup>(6)</sup></b>						
$Q_g$	Total Gate Charge	$V_{DS}=-10V, V_{GS}=-4.5V,$ $I_{DS}=-4A$		9.6		nC
$Q_{gs}$	Gate-Source Charge			1.9		
$Q_{gd}$	Gate-Drain Charge			2.8		

- Notes:
- ① Pulse width limited by safe operating area.
  - ② Calculated continuous current based on maximum allowable junction temperature.
  - ③ When mounted on 1 inch square copper board,  $t \leq 10\text{sec}$ . The value in any given application depends on the user's specific board design.
  - ④ Limited by  $T_{Jmax}$ , Starting  $T_J = 25^\circ\text{C}$ ,  $I_{ASmax} = -11A$ ,  $L = 0.5\text{mH}$ ,  $V_{DD} = -15V$ ,  $R_G = 25\Omega$ ,  $V_{GS} = -4.5V$ . Part not recommended for use above this value.
  - ⑤ Pulse test; Pulse width  $\leq 300\mu s$ , duty cycle  $\leq 2\%$ .
  - ⑥ Guaranteed by design, not subject to production testing.

**Ordering and Marking Information**

Device	Package	Packaging	Quantity	Reel Size	Tape width
KS2335AA	SOT23	Tape&Reel	3000	7"	8mm

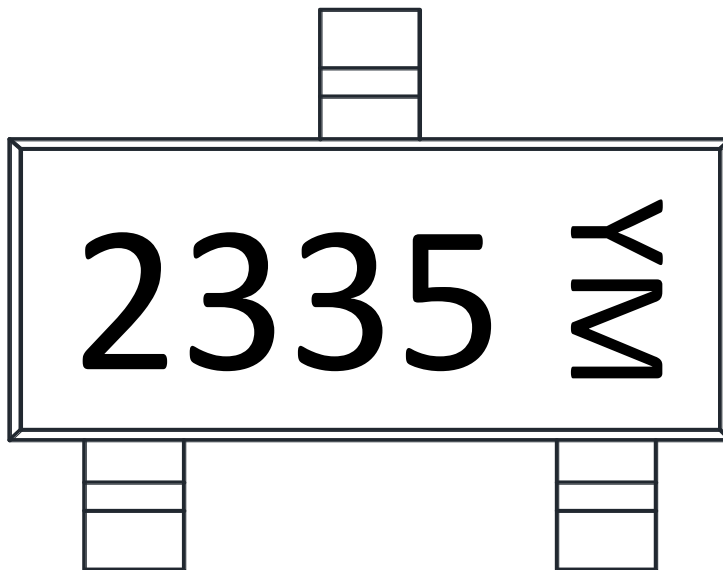

Y =Year,2017-A,2018-B,etc.

M =Month,Jan-1,Feb-2,....Sep-9,Oct-A,Nov-B,Dec-C.

Typical Characteristics

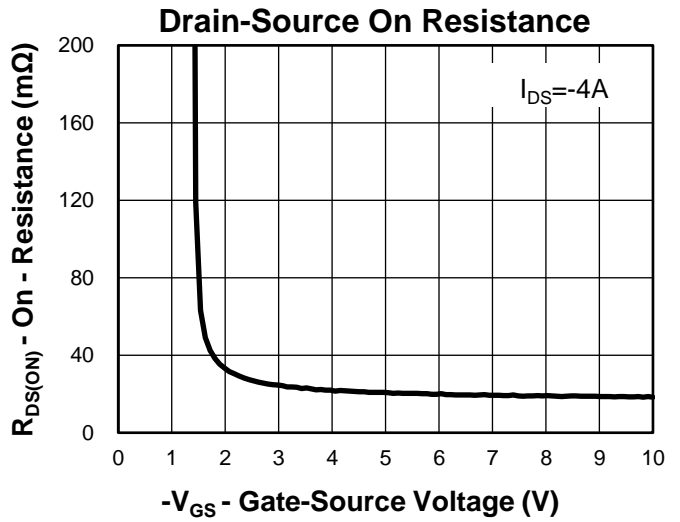
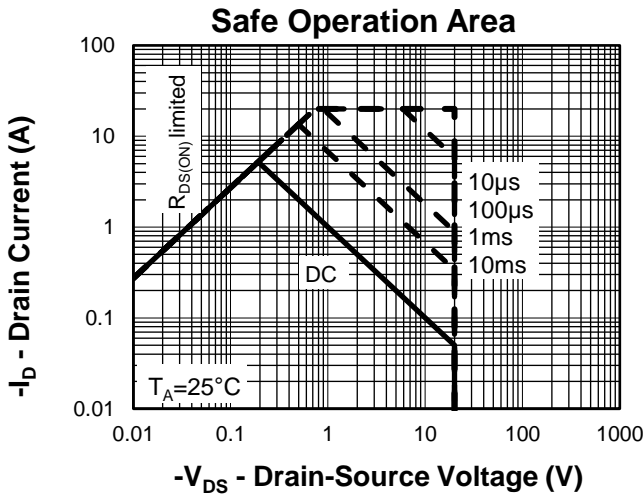
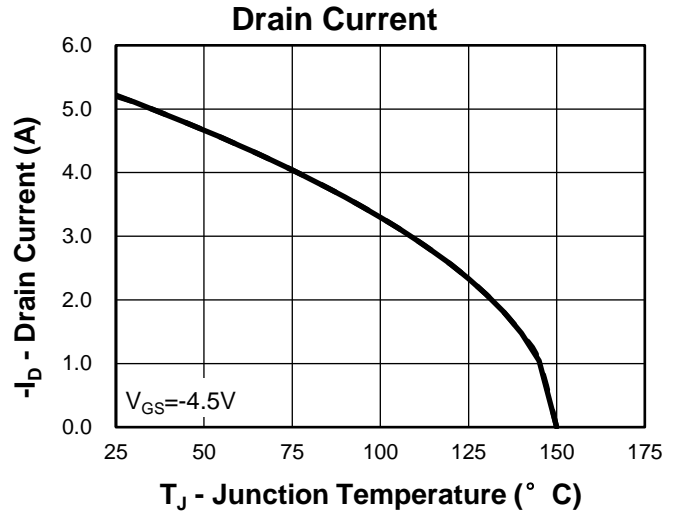
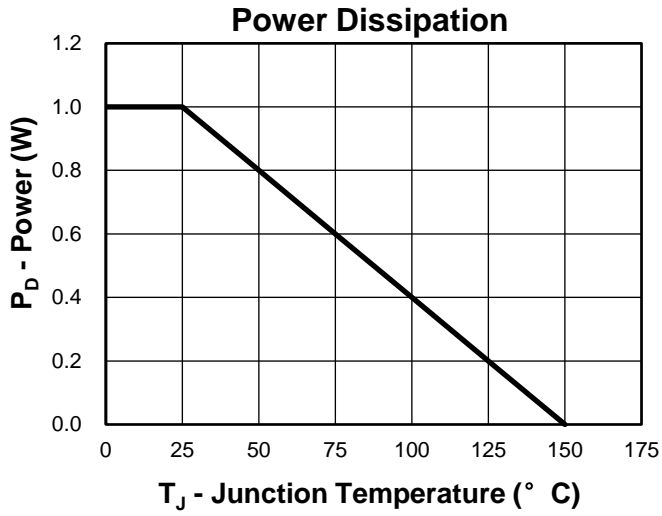

Thermal Transient Impedance

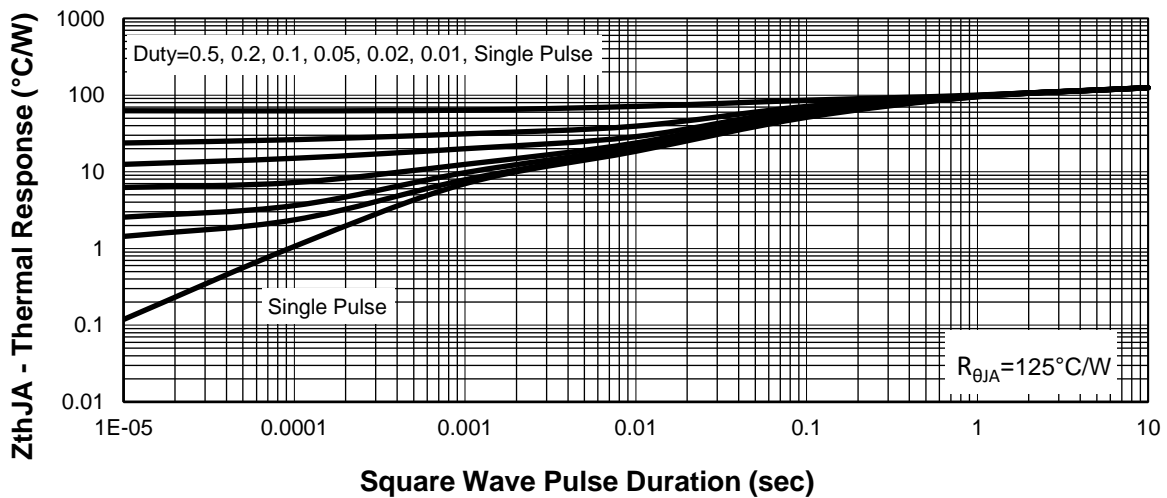

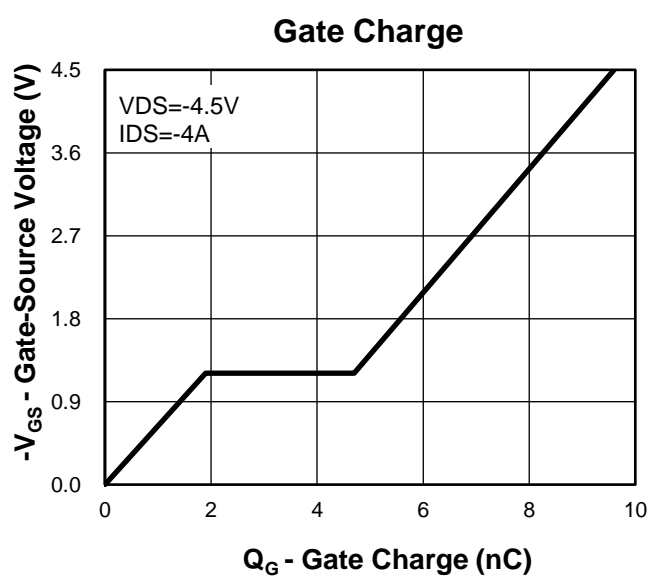
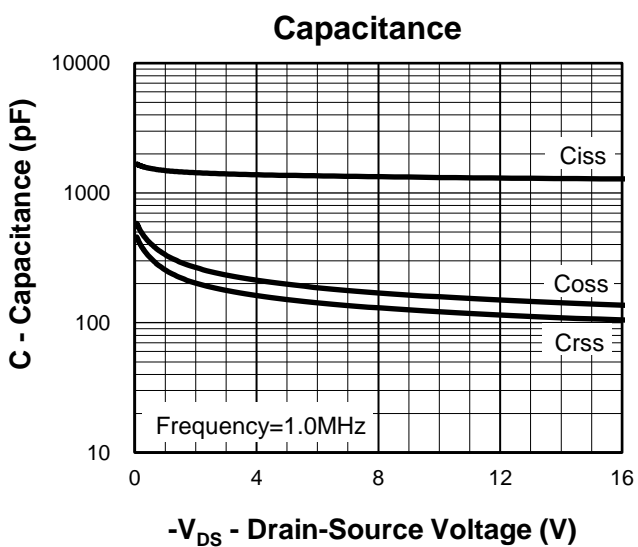
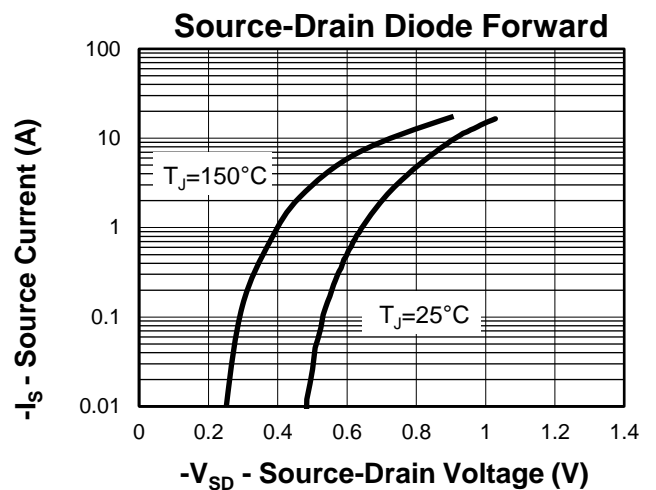
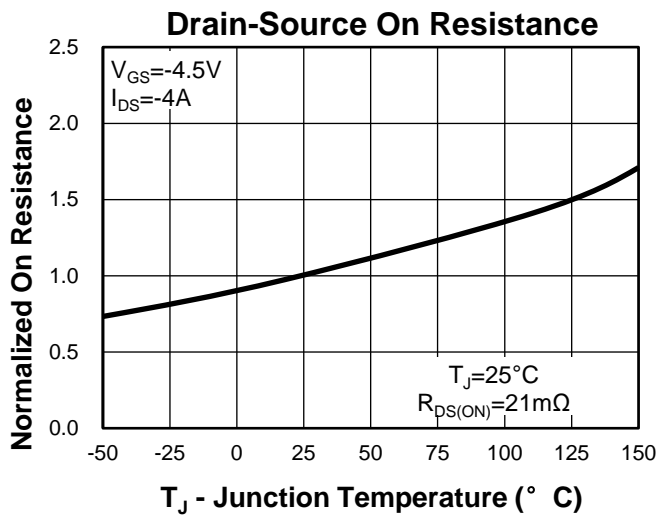
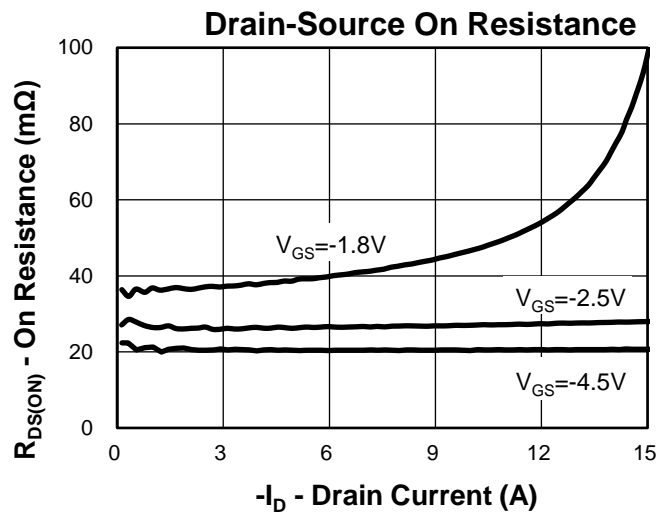
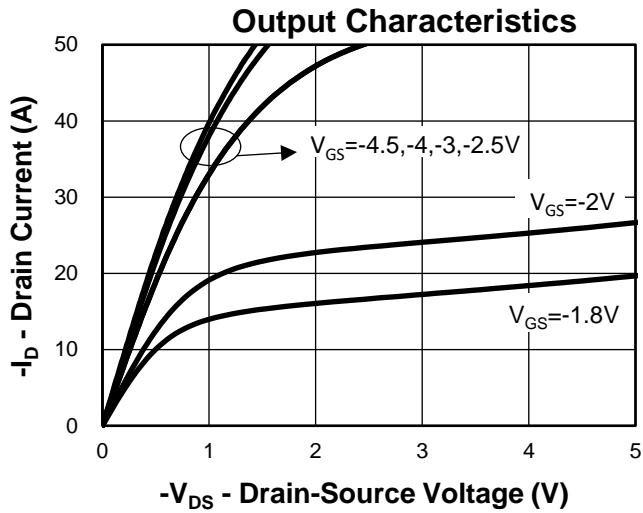
**Typical Characteristics**

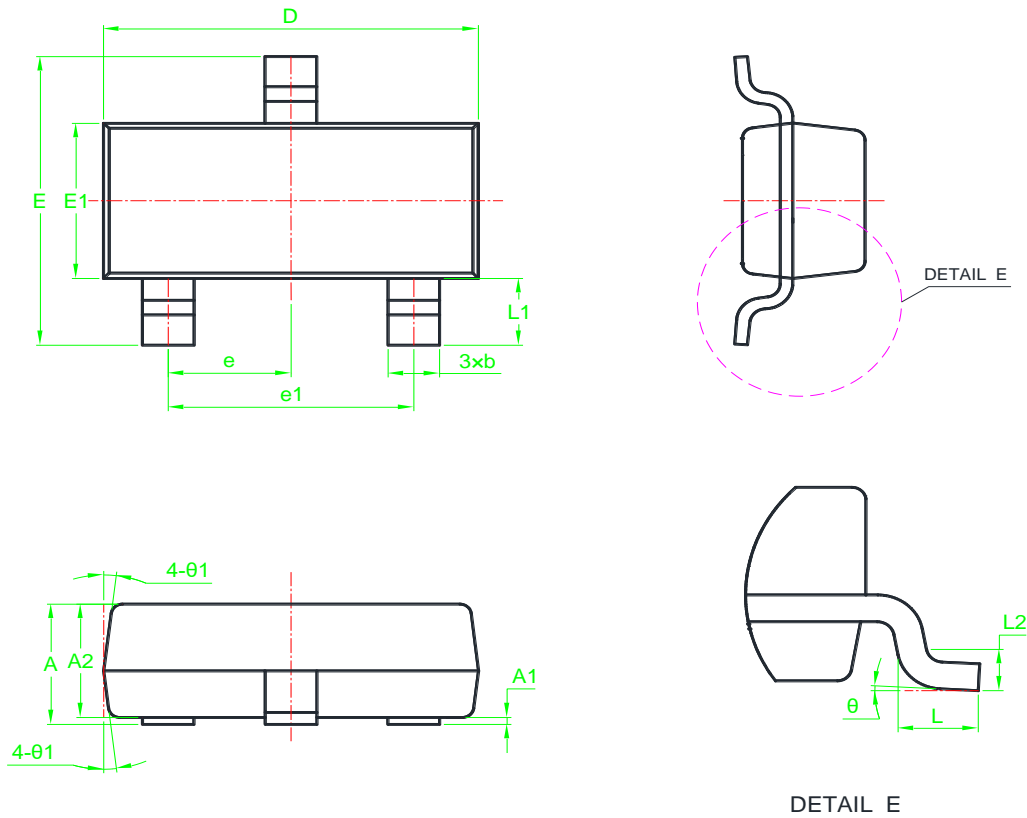
**Package Information**
**SOT23**

SYMBOL	MM			INCH			SYMBOL	MM			INCH		
	MIN	NOM	MAX	MIN	NOM	MAX		MIN	NOM	MAX	MIN	NOM	MAX
A	0.90	*	1.12	0.035	*	0.044	e	0.95BSC			0.037BSC		
A1	0.01	*	0.10	0.000	*	0.004	e1	1.90BSC			0.075BSC		
A2	0.80	0.90	1.02	0.031	0.035	0.040	L	0.30	0.40	0.50	0.012	0.016	0.020
b	0.30	0.40	0.50	0.012	0.016	0.020	L1	0.54REF			0.021REF		
D	2.80	2.90	3.00	0.110	0.114	0.118	L2	0.254BSC			0.010BSC		
E	2.25	2.40	2.55	0.089	0.094	0.100	θ	0°	*	8°	0°	*	8°
E1	1.20	1.30	1.40	0.047	0.051	0.055	θ 1	0°	*	10°	0°	*	10°

Note: Dimensions do not inclusive burrs and mold flash.

### Avalanche Test Circuit and Waveforms

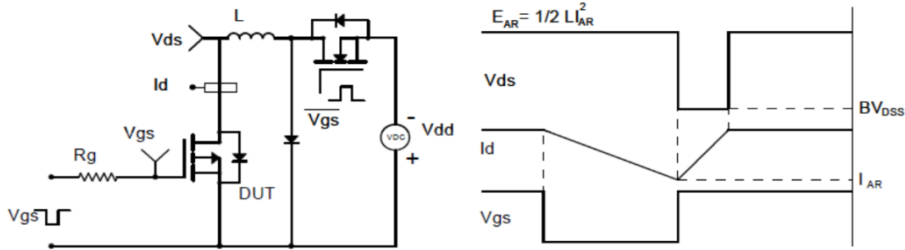

### Switching Time Test Circuit and Waveforms

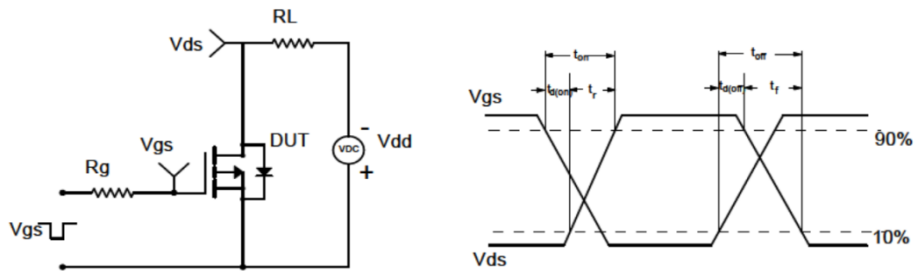

### Diode Recovery Test Circuit and Waveforms

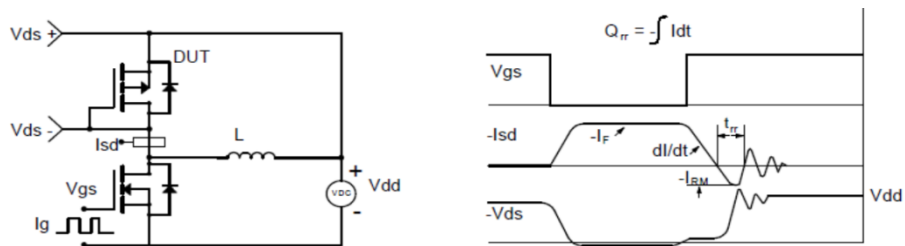

### Gate Charge Test Circuit and Waveform

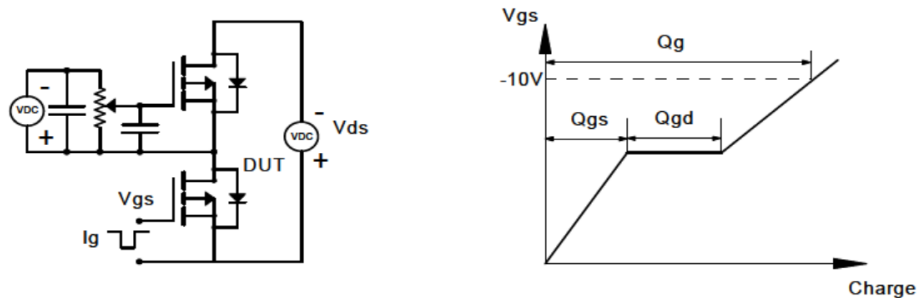

### Customer Service

Kwansemi Semiconductor Co.,Ltd

Email:Sales@kwansemi.com

Web:www.kwansemi.com

### DISCLAIMER:

Kwansemi reserves the right to change the specifications and circuitry without notice at any time. The Products are not designed for use in hostile environments, including, without limitation, aircraft, nuclear power generation, medical appliances, and devices or systems in which malfunction of any Product can reasonably be expected to result in a personal injury. Seller's customers using or selling Seller's products for use in such applications do so at their own risk and agree to fully defend and indemnify Seller.