

Features

- 250V/19A,
 $R_{DS(on)} = 90m\Omega(Typ.)@V_{GS}=10V$
- Excellent $Q_G \times R_{DS(on)}$ product(FOM)
- SGT Technology
- 100% Avalanche Tested

Applications

- Power Switching Appliaction
- LED Backlighting



Halogen-Free

Pin Description

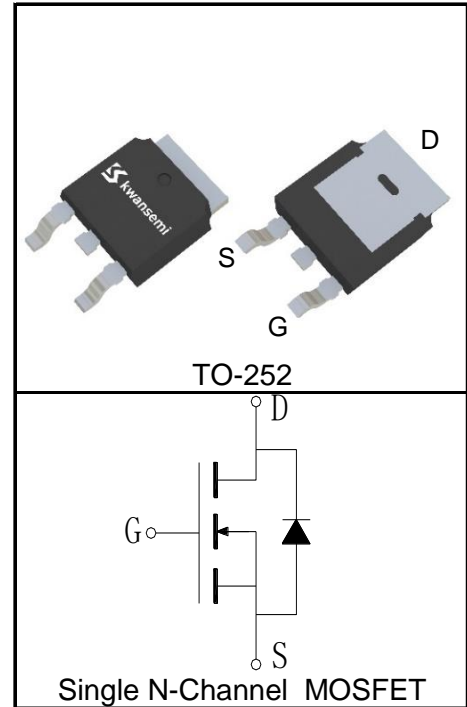

Absolute Maximum Ratings

Symbol	Parameter	Rating	Unit
Common Ratings ($T_C=25^\circ\text{C}$ Unless Otherwise Noted)			
V_{DSS}	Drain-Source Voltage	250	V
V_{GSS}	Gate-Source Voltage	± 20	
T_{Jmax}	Maximum Junction Temperature	175	$^\circ\text{C}$
T_J, T_{STG}	Operating and Storage Temperature Range	-55 to 175	$^\circ\text{C}$
I_S	Diode Continuous Forward Current	$T_C=25^\circ\text{C}$ 19	A
Mounted on Large Heat Sink			
$I_{DP}^{①}$	Pulse Drain Current	$T_C=25^\circ\text{C}$ 76	A
$I_D^{②}$	Continuous Drain Current($V_{GS}=10V$)	$T_C=25^\circ\text{C}$ 19	A
		$T_C=100^\circ\text{C}$ 13	
P_D	Maximum Power Dissipation	$T_C=25^\circ\text{C}$ 107	W
		$T_C=100^\circ\text{C}$ 53	
$R_{\theta JC}$	Thermal Resistance-Junction to Case	1.4	$^\circ\text{C}/\text{W}$
$R_{\theta JA}^{③}$	Thermal Resistance-Junction to Ambient	100	$^\circ\text{C}/\text{W}$
Drain-Source Avalanche Ratings			
$E_{AS}^{④}$	Avalanche Energy, Single Pulsed	210	mJ

Electrical Characteristics ($T_C=25^\circ\text{C}$ Unless Otherwise Noted)

Symbol	Parameter	Test Condition	KSD2040DAT			Unit
			Min.	Typ.	Max.	
Static Characteristics						
BV_{DSS}	Drain-Source Breakdown Voltage	$V_{GS}=0V, I_{DS}=250\mu A$	250			V
I_{DSS}	Zero Gate Voltage Drain Current	$V_{DS}=250V, V_{GS}=0V$			1	μA
		$T_J=125^\circ\text{C}$			30	
$V_{GS(th)}$	Gate Threshold Voltage	$V_{DS}=V_{GS}, I_{DS}=250\mu A$	2.5	3.5	4.5	V
I_{GSS}	Gate Leakage Current	$V_{GS}=\pm 20V, V_{DS}=0V$			± 100	nA
$R_{DS(ON)}^{(5)}$	Drain-Source On-state Resistance	$V_{GS}=10V, I_{DS}=15A$		90	105	m Ω
Diode Characteristics						
$V_{SD}^{(5)}$	Diode Forward Voltage	$I_{SD}=15A, V_{GS}=0V$		0.86	1.2	V
t_{rr}	Reverse Recovery Time	$I_{SD}=15A, di_{SD}/dt=100A/\mu s$		69		ns
Q_{rr}	Reverse Recovery Charge			237		nC
Dynamic Characteristics⁽⁶⁾						
R_G	Gate Resistance	$V_{GS}=0V, V_{DS}=0V, F=1\text{MHz}$		1.2		Ω
C_{iss}	Input Capacitance	$V_{GS}=0V,$ $V_{DS}=125V,$ Frequency=1.0MHz		2325		pF
C_{oss}	Output Capacitance			65		
C_{riss}	Reverse Transfer Capacitance			10		
$t_{d(ON)}$	Turn-on Delay Time	$V_{DD}=125V, I_{DS}=15A,$ $V_{GEN}=10V, R_G=3\Omega$		10		ns
t_r	Turn-on Rise Time			17		
$t_{d(OFF)}$	Turn-off Delay Time			24		
t_f	Turn-off Fall Time			12		
Gate Charge Characteristics⁽⁶⁾						
Q_g	Total Gate Charge	$V_{DS}=125V, V_{GS}=10V,$ $I_{DS}=15A$		34		nC
Q_{gs}	Gate-Source Charge			13		
Q_{gd}	Gate-Drain Charge			7.8		

- Notes:
- ① Pulse width limited by safe operating area.
 - ② Calculated continuous current based on maximum allowable junction temperature.
 - ③ When mounted on 1 inch square copper board, $t \leq 10\text{sec}$. The value in any given application depends on the user's specific board design.
 - ④ Limited by T_{Jmax} , Starting $T_J = 25^\circ\text{C}$, $I_{ASmax} = 29A$, $L = 0.5\text{mH}$, $V_{DD} = 48V$, $R_G = 25\Omega$, $V_{GS} = 10V$. Part not recommended for use above this value. 100% Final Test at $I_{AS} = 20A$, $L = 0.5\text{mH}$.
 - ⑤ Pulse test; Pulse width $\leq 300\mu s$, duty cycle $\leq 2\%$.
 - ⑥ Guaranteed by design, not subject to production testing.

Ordering and Marking Information

Device	Package	Packaging	Quantity	Reel Size	Tape width
KSD2040DAT	TO-252	Tape&Reel	2500	13"	16mm

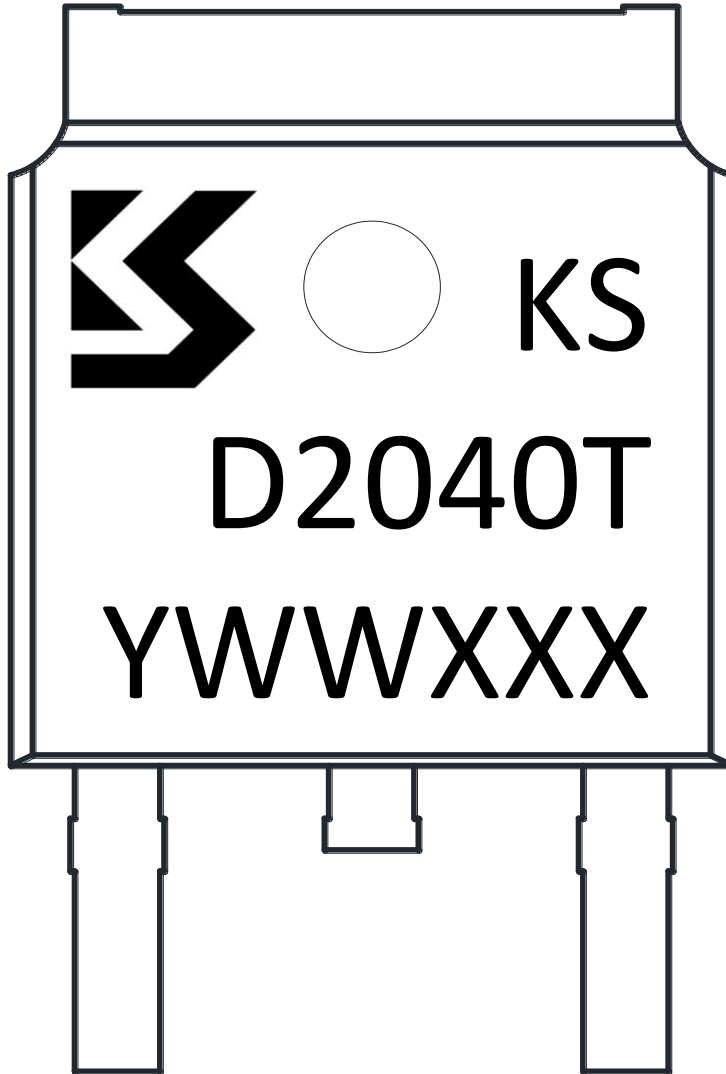

1st Line: Kwansemi LOGO, Kwansemi Code(KS)
2nd Line: Part Number(D2040T)
3rd Line: Lot Number(YWWXXX)

Typical Characteristics

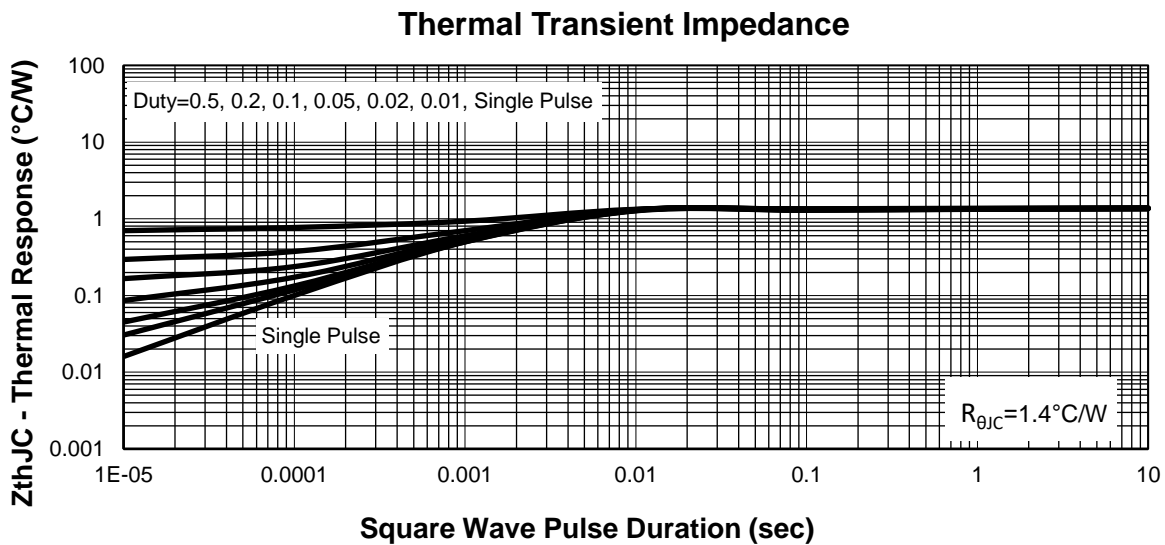
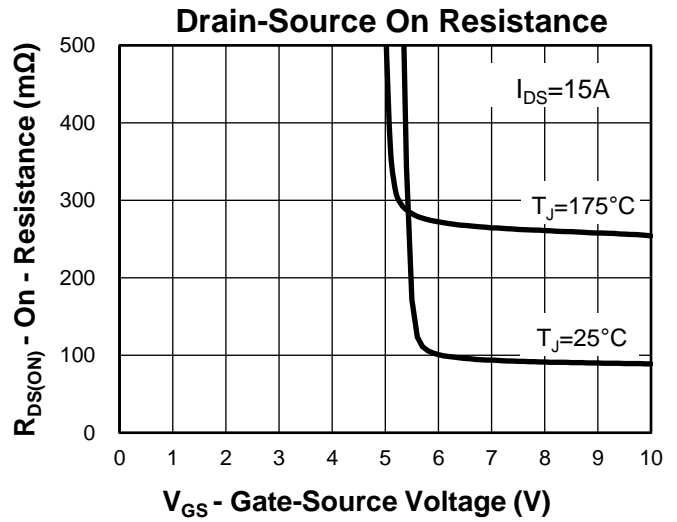
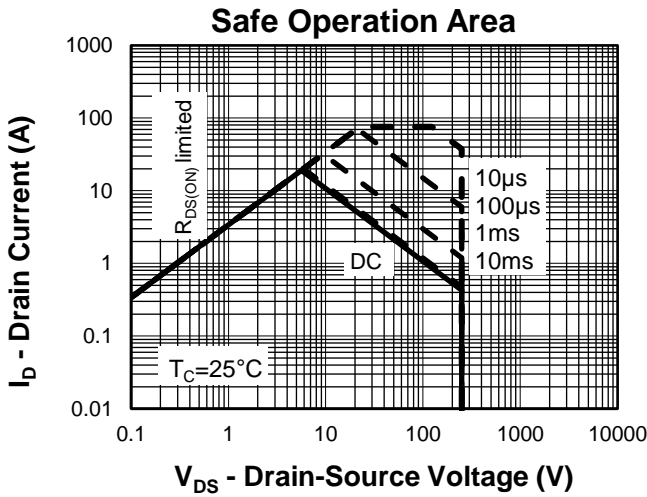
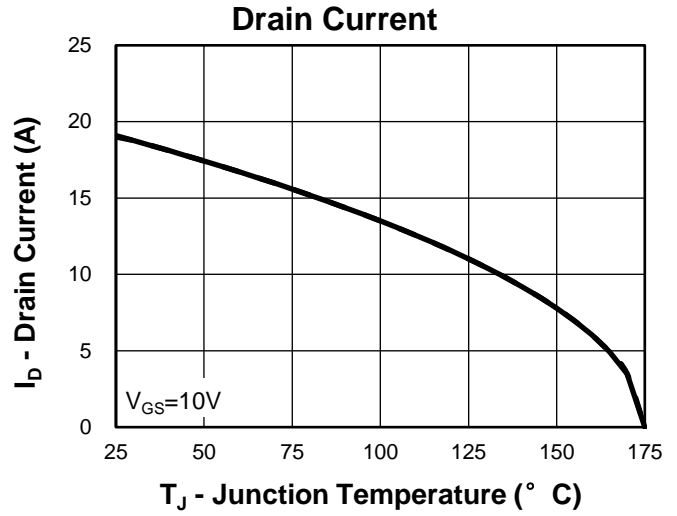
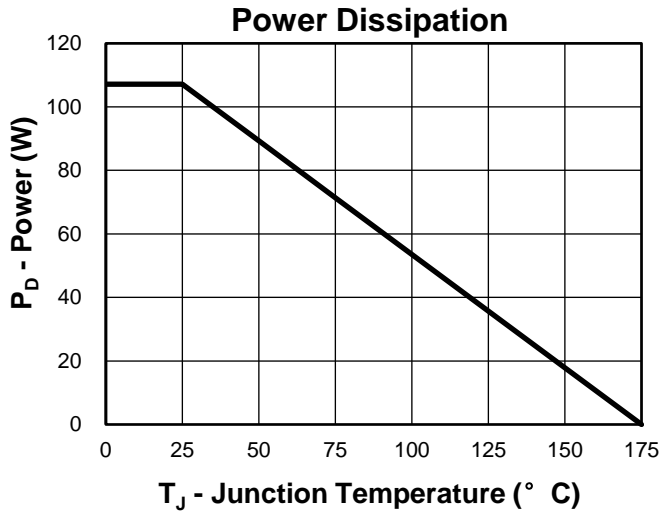

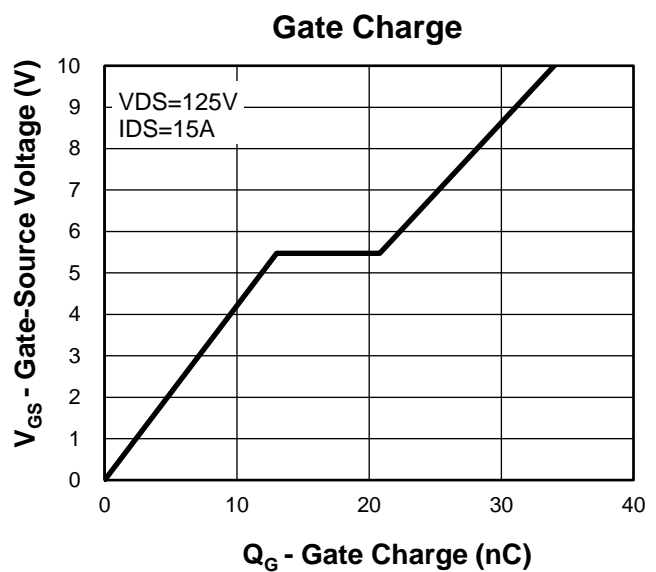
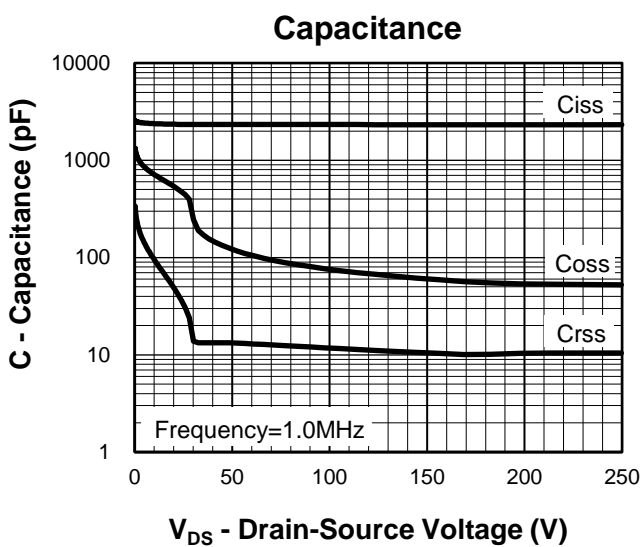
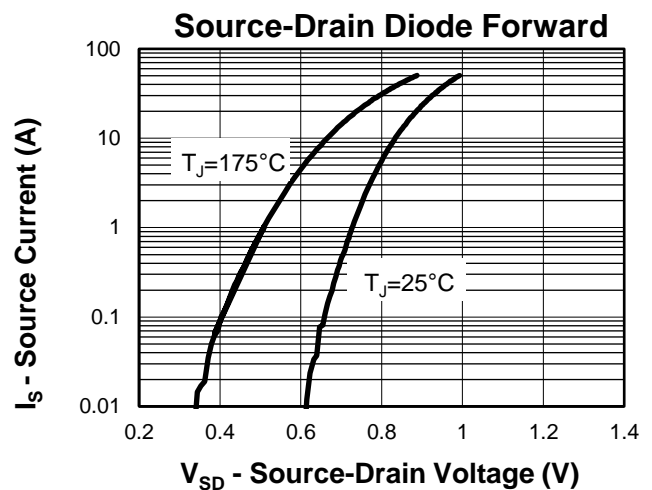
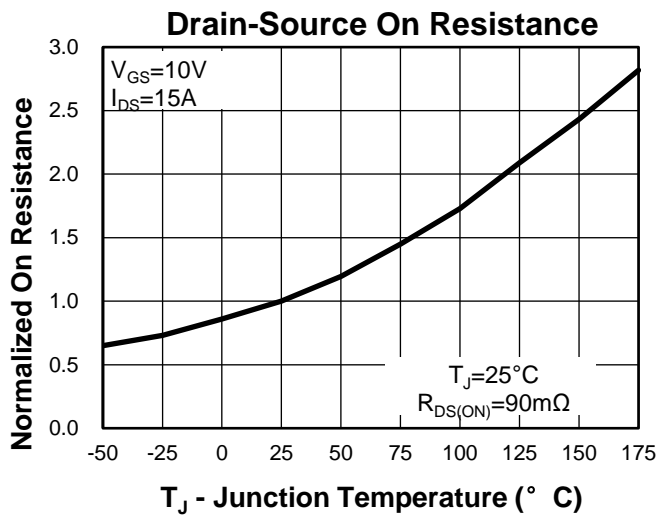
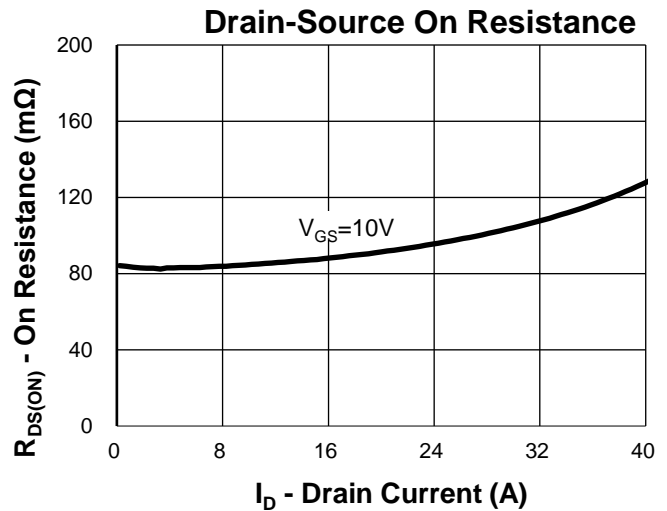
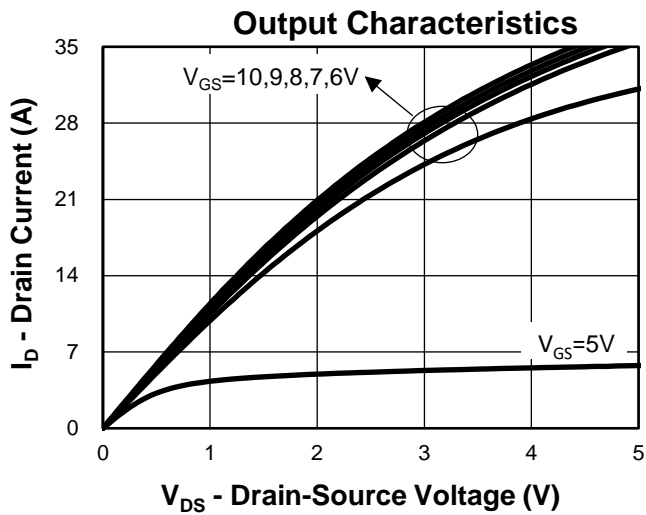
Typical Characteristics

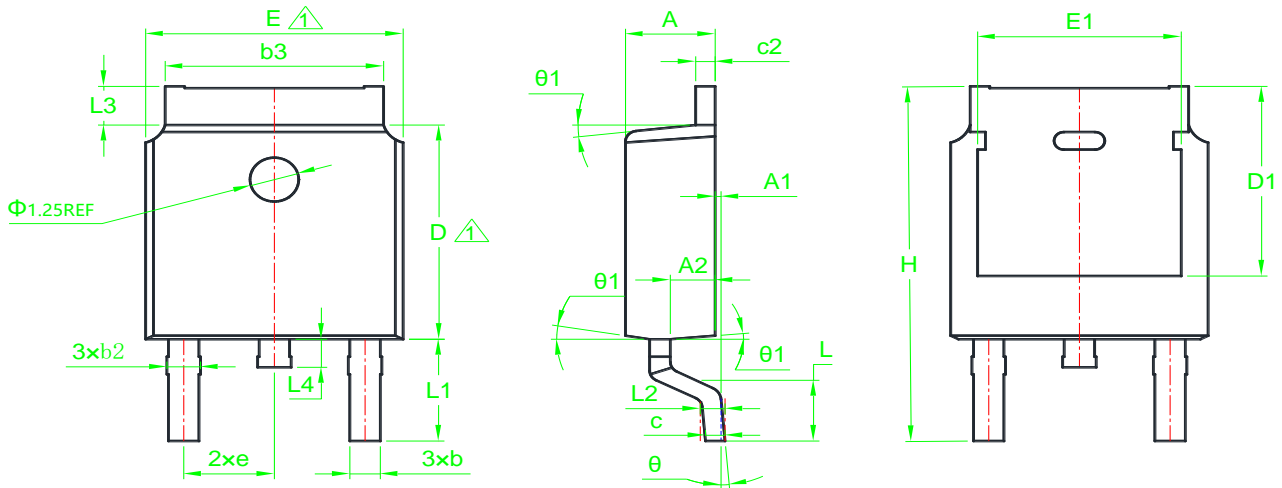
Package Information
TO-252

SYMBOL	MM			INCH			SYMBOL	MM			INCH		
	MIN	NOM	MAX	MIN	NOM	MAX		MIN	NOM	MAX	MIN	NOM	MAX
A	2.20	2.30	2.38	0.087	0.091	0.094	E	6.40	6.60	6.70	0.252	0.260	0.264
A1	0.00	*	0.15	0.000	*	0.006	E1	4.55	*	5.15	0.179	*	0.203
A2	0.90	1.00	1.10	0.035	0.039	0.043	H	9.60	10.10	10.40	0.378	0.398	0.409
b	0.65	0.75	0.85	0.026	0.030	0.033	L	1.40	1.50	1.70	0.055	0.059	0.067
b2	0.72	*	0.90	0.028	*	0.035	L1	2.90REF			0.114REF		
b3	5.13	5.33	5.46	0.202	0.210	0.215	L2	0.508BSC			0.020BSC		
c	0.47	0.51	0.54	0.019	0.020	0.021	L3	0.90	*	1.25	0.035	*	0.049
D	6.00	6.10	6.20	0.236	0.240	0.244	L4	0.60	*	1.00	0.024	*	0.039
D1	5.25	5.35	5.60	0.207	0.211	0.220	θ	0°	*	10°	0°	*	10°
e	2.286BSC			0.090BSC			θ1	5°	*	9°	5°	*	9°

 Dimensions D and E do not include mold flash protrusions or gate burrs.

Avalanche Test Circuit and Waveforms



Switching Time Test Circuit and Waveforms



Diode Recovery Test Circuit and Waveforms



Gate Charge Test Circuit and Waveform



Customer Service

Kwansemi Semiconductor Co.,Ltd

Email:Sales@kwansemi.com

Web:www.kwansemi.com

DISCLAIMER:

Kwansemi reserves the right to change the specifications and circuitry without notice at any time. The Products are not designed for use in hostile environments, including, without limitation, aircraft, nuclear power generation, medical appliances, and devices or systems in which malfunction of any Product can reasonably be expected to result in a personal injury. Seller's customers using or selling Seller's products for use in such applications do so at their own risk and agree to fully defend and indemnify Seller.