

## Features

- 70V/94A,  
 $R_{DS(ON)} = 4.8m\Omega(Typ.)@V_{GS}=10V$
- Excellent  $Q_G \times R_{DS(on)}$  product(FOM)
- SGT Technology
- 100% Avalanche Tested

## Applications

- Energy Storage
- DC/DC Converter



Halogen-Free

## Pin Description

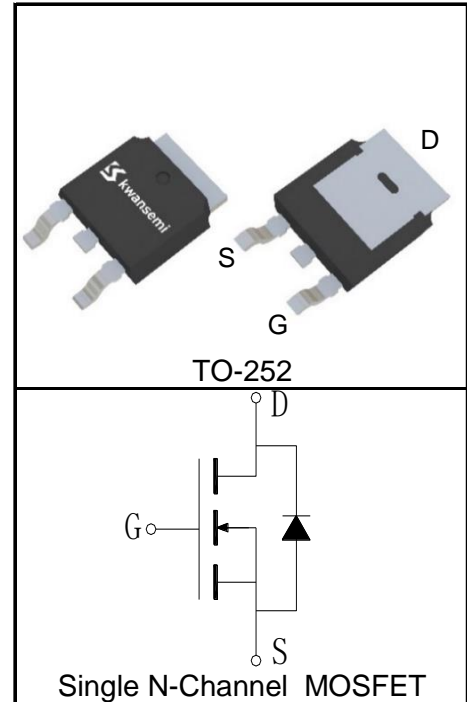

## Absolute Maximum Ratings

Symbol	Parameter	Rating	Unit
<b>Common Ratings</b> ( $T_C=25^\circ\text{C}$ Unless Otherwise Noted)			
$V_{DSS}$	Drain-Source Voltage	70	V
$V_{GSS}$	Gate-Source Voltage	$\pm 20$	
$T_{Jmax}$	Maximum Junction Temperature	175	$^\circ\text{C}$
$T_J, T_{STG}$	Operating and Storage Temperature Range	-55 to 175	$^\circ\text{C}$
$I_S$	Diode Continuous Forward Current	$T_C=25^\circ\text{C}$ 94	A
<b>Mounted on Large Heat Sink</b>			
$I_{DP}^{①}$	Pulse Drain Current	$T_C=25^\circ\text{C}$ 376	A
$I_D^{②}$	Continuous Drain Current( $V_{GS}=10V$ )	$T_C=25^\circ\text{C}$ 94	A
		$T_C=100^\circ\text{C}$ 66	
$P_D$	Maximum Power Dissipation	$T_C=25^\circ\text{C}$ 93	W
		$T_C=100^\circ\text{C}$ 46	
$R_{\theta JC}$	Thermal Resistance-Junction to Case	1.6	$^\circ\text{C}/\text{W}$
$R_{\theta JA}^{③}$	Thermal Resistance-Junction to Ambient	100	$^\circ\text{C}/\text{W}$
<b>Drain-Source Avalanche Ratings</b>			
$E_{AS}^{④}$	Avalanche Energy, Single Pulsed	324	mJ

**Electrical Characteristics** ( $T_C=25^\circ\text{C}$  Unless Otherwise Noted)

Symbol	Parameter	Test Condition	KS7205DAT			Unit
			Min.	Typ.	Max.	
<b>Static Characteristics</b>						
$BV_{DSS}$	Drain-Source Breakdown Voltage	$V_{GS}=0V, I_{DS}=250\mu A$	70			V
$I_{DSS}$	Zero Gate Voltage Drain Current	$V_{DS}=70V, V_{GS}=0V$			1	$\mu A$
		$T_J=125^\circ\text{C}$			30	
$V_{GS(th)}$	Gate Threshold Voltage	$V_{DS}=V_{GS}, I_{DS}=250\mu A$	2	3	4	V
$I_{GSS}$	Gate Leakage Current	$V_{GS}=\pm 20V, V_{DS}=0V$			$\pm 100$	nA
$R_{DS(ON)}^{(5)}$	Drain-Source On-state Resistance	$V_{GS}=10V, I_{DS}=40A$		4.8	5.9	$m\Omega$
		$V_{GS}=6V, I_{DS}=20A$		6.8	8.5	$m\Omega$
<b>Diode Characteristics</b>						
$V_{SD}^{(5)}$	Diode Forward Voltage	$I_{SD}=40A, V_{GS}=0V$		0.9	1.2	V
$t_{rr}$	Reverse Recovery Time	$I_{SD}=40A, dI_{SD}/dt=100A/\mu s$		47		ns
$Q_{rr}$	Reverse Recovery Charge			132		nC
<b>Dynamic Characteristics<sup>(6)</sup></b>						
$R_G$	Gate Resistance	$V_{GS}=0V, V_{DS}=0V, F=1\text{MHz}$		1.8		$\Omega$
$C_{iss}$	Input Capacitance	$V_{GS}=0V,$ $V_{DS}=35V,$ Frequency=200KHz		2115		pF
$C_{oss}$	Output Capacitance			750		
$C_{rss}$	Reverse Transfer Capacitance			50		
$t_{d(ON)}$	Turn-on Delay Time	$V_{DD}=35V, I_{DS}=40A,$ $V_{GEN}=10V, R_G=3\Omega$		12		ns
$t_r$	Turn-on Rise Time			11		
$t_{d(OFF)}$	Turn-off Delay Time			33		
$t_f$	Turn-off Fall Time			24		
<b>Gate Charge Characteristics<sup>(6)</sup></b>						
$Q_g$	Total Gate Charge	$V_{DS}=35V, V_{GS}=10V,$ $I_{DS}=40A$		42		nC
$Q_{gs}$	Gate-Source Charge			9.6		
$Q_{gd}$	Gate-Drain Charge			14		

- Notes:
- ① Pulse width limited by safe operating area.
  - ② Calculated continuous current based on maximum allowable junction temperature. The package limitation current is 60A.
  - ③ When mounted on 1 inch square copper board,  $t \leq 10\text{sec}$ . The value in any given application depends on the user's specific board design.
  - ④ Limited by  $T_{Jmax}$ , Starting  $T_J = 25^\circ\text{C}$ ,  $I_{ASmax} = 36A$ ,  $L=0.5\text{mH}$ ,  $V_{DD} = 48V$ ,  $R_G = 25\Omega$ ,  $V_{GS}=10V$ . Part not recommended for use above this value. 100% Final Test at  $I_{AS}=25A$ ,  $L=0.5\text{mH}$ .
  - ⑤ Pulse test; Pulse width  $\leq 300\mu s$ , duty cycle  $\leq 2\%$ .
  - ⑥ Guaranteed by design, not subject to production testing.

**Ordering and Marking Information**

Device	Package	Packaging	Quantity	Reel Size	Tape width
KS7205DAT	TO-252	Tape&Reel	2500	13"	16mm

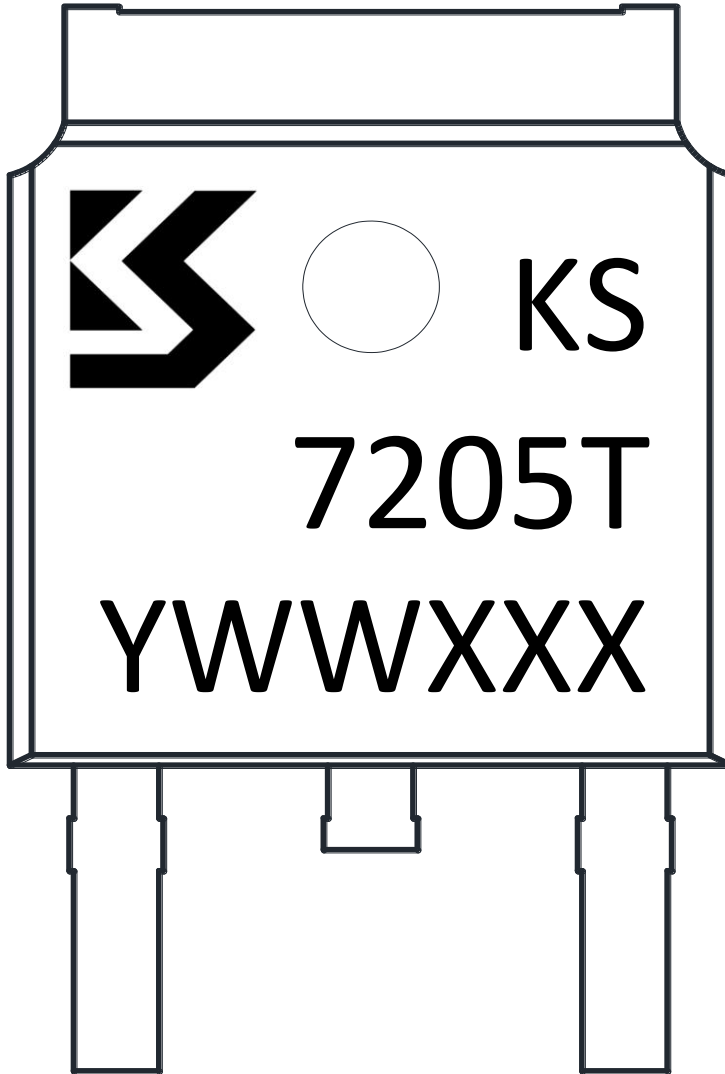

1st Line: Kwansemi LOGO, Kwansemi Code(KS)  
2nd Line: Part Number(7205T)  
3rd Line: Lot Number(YWWXXX)

### Typical Characteristics

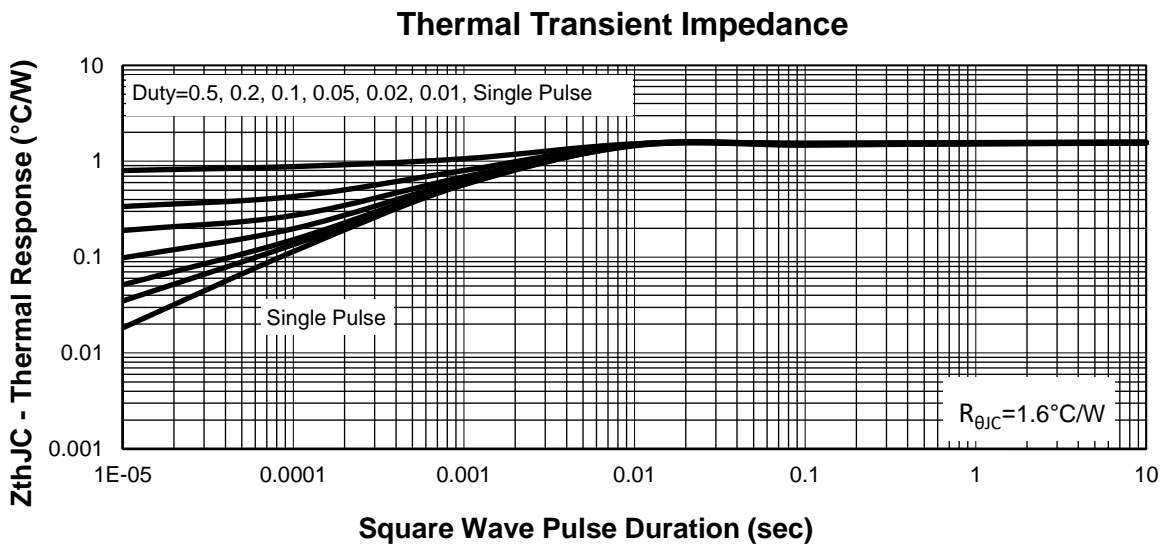
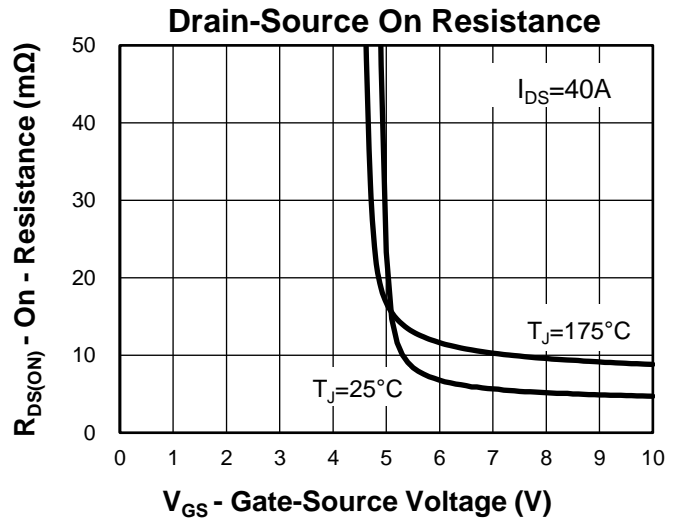
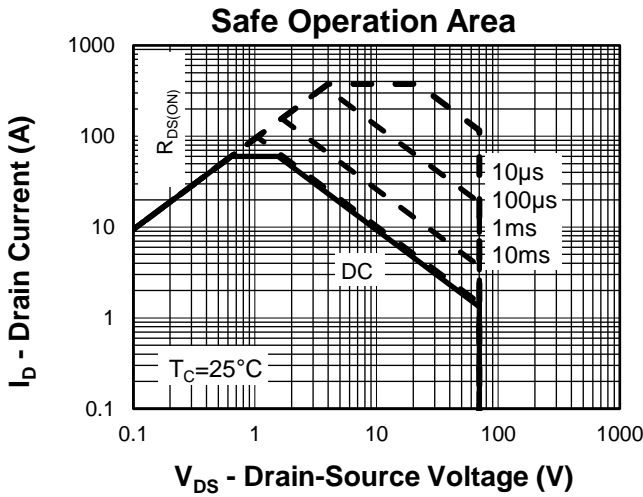
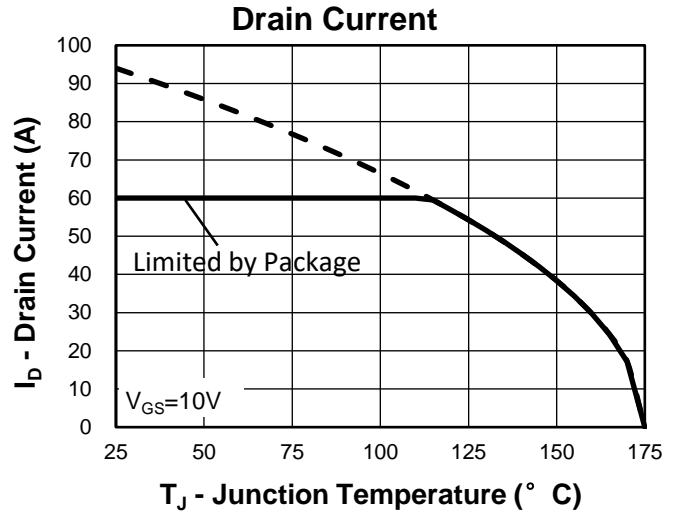
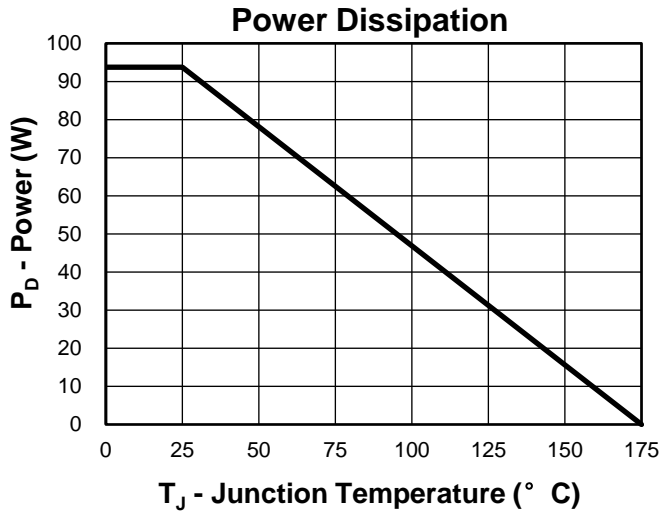

### Typical Characteristics

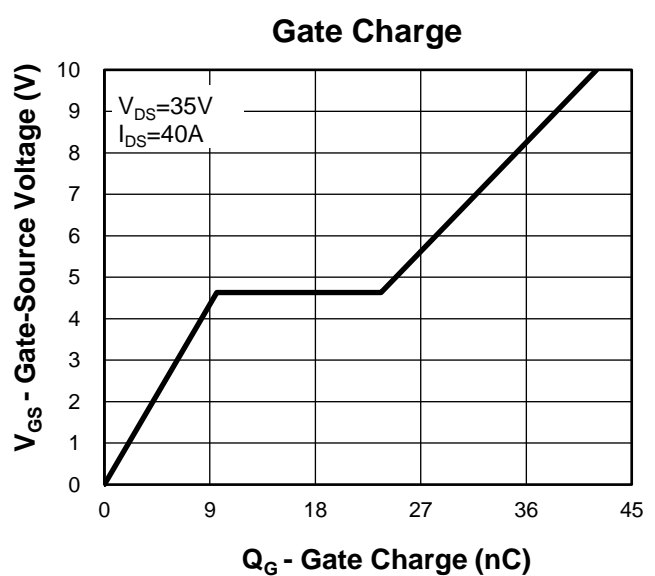
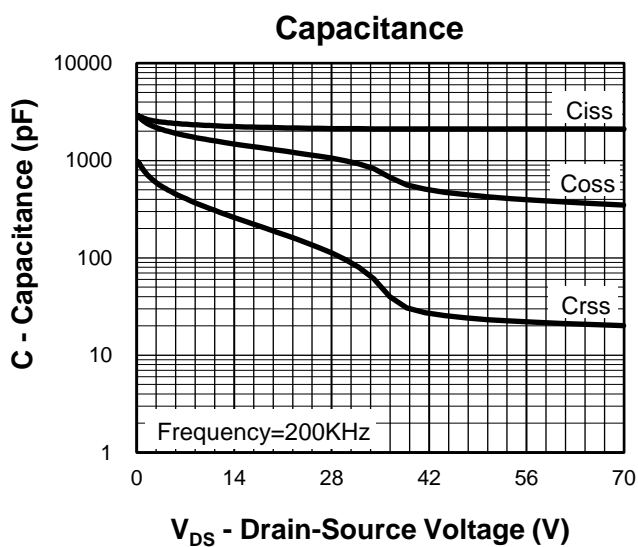
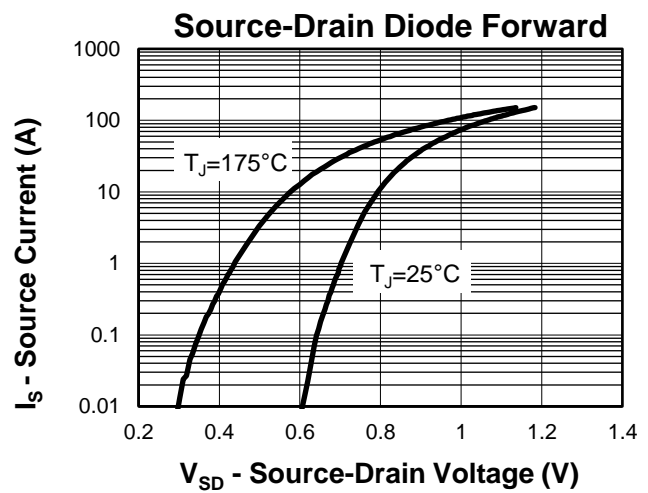
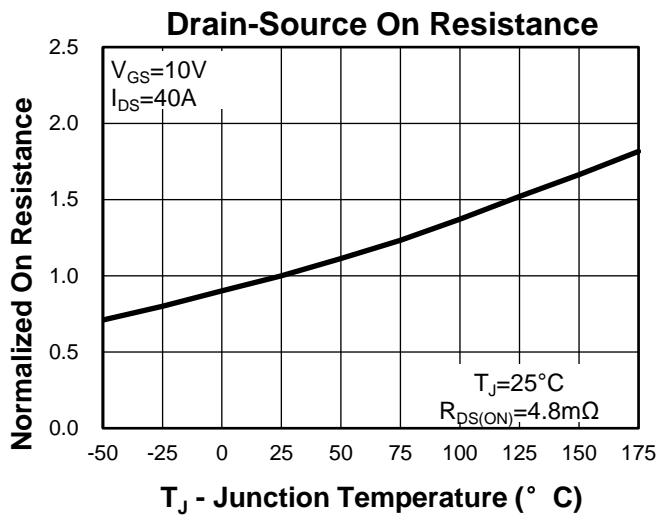
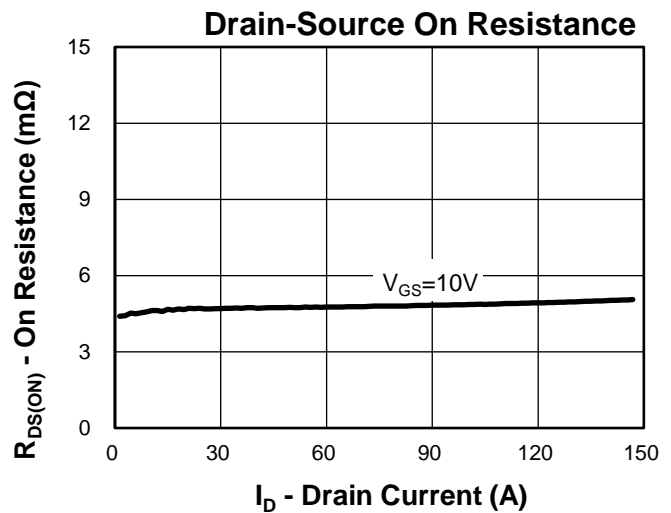
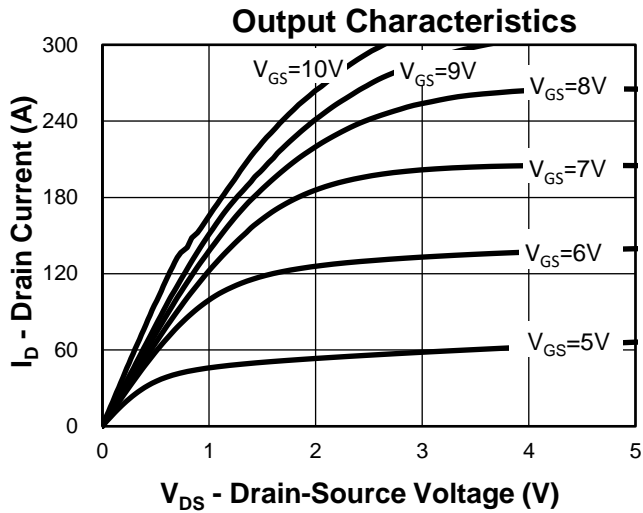

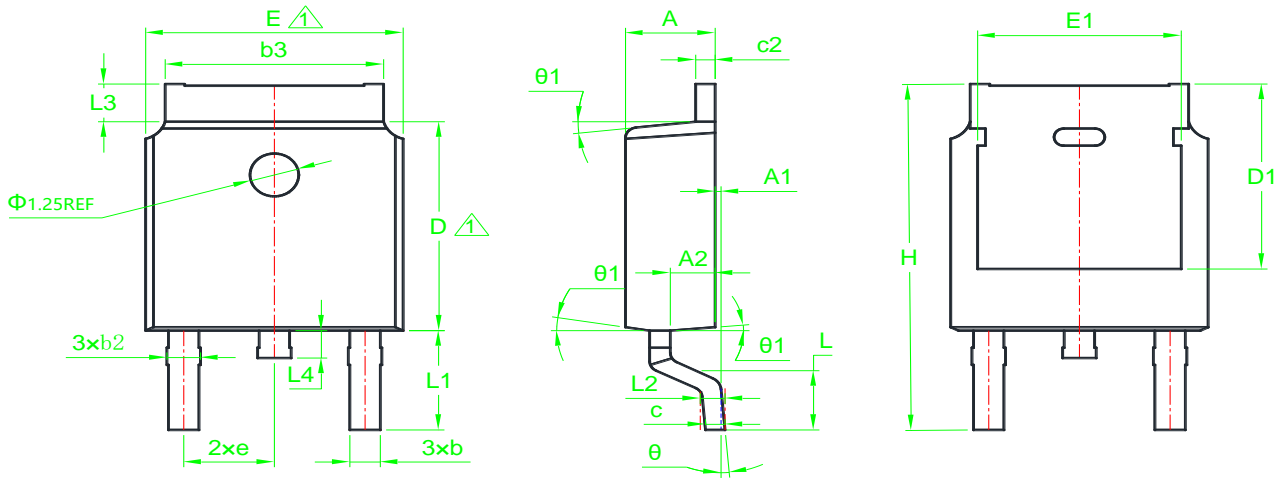
**Package Information**
**TO-252**

SYMBOL	MM			INCH			SYMBOL	MM			INCH		
	MIN	NOM	MAX	MIN	NOM	MAX		MIN	NOM	MAX	MIN	NOM	MAX
A	2.20	2.30	2.38	0.087	0.091	0.094	E	6.40	6.60	6.70	0.252	0.260	0.264
A1	0.00	*	0.15	0.000	*	0.006	E1	4.55	*	5.15	0.179	*	0.203
A2	0.90	1.00	1.10	0.035	0.039	0.043	H	9.60	10.10	10.40	0.378	0.398	0.409
b	0.65	0.75	0.85	0.026	0.030	0.033	L	1.40	1.50	1.70	0.055	0.059	0.067
b2	0.72	*	0.90	0.028	*	0.035	L1	2.90REF			0.114REF		
b3	5.13	5.33	5.46	0.202	0.210	0.215	L2	0.508BSC			0.020BSC		
c	0.47	0.51	0.54	0.019	0.020	0.021	L3	0.90	*	1.25	0.035	*	0.049
D	6.00	6.10	6.20	0.236	0.240	0.244	L4	0.60	*	1.00	0.024	*	0.039
D1	5.25	5.35	5.60	0.207	0.211	0.220	θ	0°	*	10°	0°	*	10°
e	2.286BSC			0.090BSC			θ1	5°	*	9°	5°	*	9°

△1 Dimensions D and E do not include mold flash protrusions or gate burrs.

### Avalanche Test Circuit and Waveforms

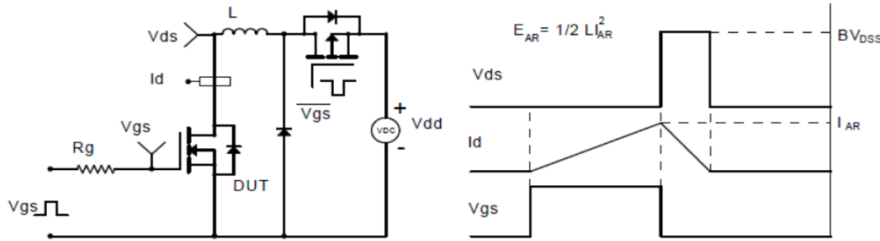

### Switching Time Test Circuit and Waveforms

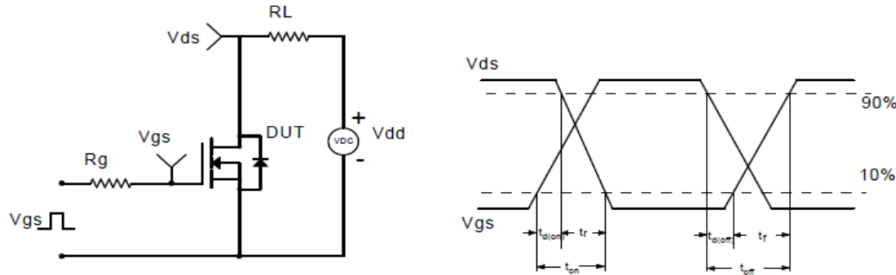

### Diode Recovery Test Circuit and Waveforms

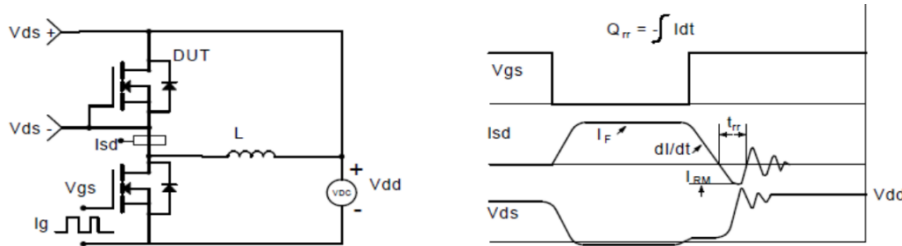

### Gate Charge Test Circuit and Waveform

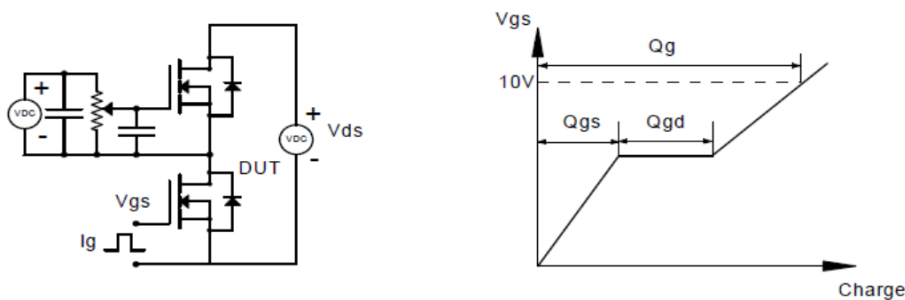

### Customer Service

Kwansemi Semiconductor Co.,Ltd

Email:Sales@kwansemi.com

Web:www.kwansemi.com

### DISCLAIMER:

Kwansemi reserves the right to change the specifications and circuitry without notice at any time. The Products are not designed for use in hostile environments, including, without limitation, aircraft, nuclear power generation, medical appliances, and devices or systems in which malfunction of any Product can reasonably be expected to result in a personal injury. Seller's customers using or selling Seller's products for use in such applications do so at their own risk and agree to fully defend and indemnify Seller.