

### Features

- 85V/85A,  
 $R_{DS(ON)} = 5m\Omega(Typ.)@V_{GS}=10V$
- Excellent  $Q_G \times R_{DS(on)}$  product(FOM)
- SGT Technology
- 100% avalanche tested

### Applications

- Switching Application Systems
- DC/DC Converter



### Pin Description

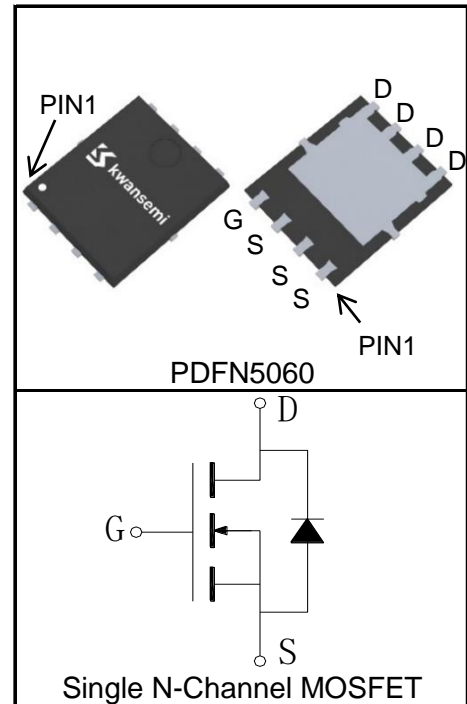

### Absolute Maximum Ratings

Symbol	Parameter	Rating	Unit
<b>Common Ratings</b> ( $T_C=25^\circ C$ Unless Otherwise Noted)			
$V_{DSS}$	Drain-Source Voltage	85	V
$V_{GSS}$	Gate-Source Voltage	$\pm 20$	V
$T_{Jmax}$	Maximum Junction Temperature	150	$^\circ C$
$T_J, T_{STG}$	Operating and Storage Temperature Range	-55 to 150	$^\circ C$
$I_S$	Diode Continuous Forward Current	$T_C=25^\circ C$ 85	A
<b>Mounted on Large Heat Sink</b>			
$I_{DP}^{①}$	Pulse Drain Current	$T_C=25^\circ C$ 340	A
$I_D^{②}$	Continuous Drain Current@ $T_C(V_{GS}=10V)$	$T_C=25^\circ C$ 85	A
		$T_C=100^\circ C$ 53	
	Continuous Drain Current@ $T_A(V_{GS}=10V)^{③}$	$T_A=25^\circ C$ 19	
		$T_A=70^\circ C$ 15	
$P_D$	Maximum Power Dissipation@ $T_C$	$T_C=25^\circ C$ 78	W
		$T_C=100^\circ C$ 31	
	Maximum Power Dissipation@ $T_A^{③}$	$T_A=25^\circ C$ 4.2	
		$T_A=70^\circ C$ 2.7	

Symbol	Parameter	Rating	Unit
$R_{\theta JC}$	Thermal Resistance-Junction to Case	1.6	°C/W
$R_{\theta JA}$ ③	Thermal Resistance-Junction to Ambient	30	°C/W
<b>Drain-Source Avalanche Ratings</b>			
$E_{AS}$ ④	Avalanche Energy, Single Pulsed	441	mJ

**Electrical Characteristics** ( $T_C=25^\circ\text{C}$  Unless Otherwise Noted)

Symbol	Parameter	Test Condition	KS92034NBT			Unit
			Min.	Typ.	Max.	
<b>Static Characteristics</b>						
$BV_{DSS}$	Drain-Source Breakdown Voltage	$V_{GS}=0V, I_{DS}=250\mu A$	85			V
$I_{DSS}$	Zero Gate Voltage Drain Current	$V_{DS}=85V, V_{GS}=0V$			1	$\mu A$
		$T_J=125^\circ C$			30	
$V_{GS(th)}$	Gate Threshold Voltage	$V_{DS}=V_{GS}, I_{DS}=250\mu A$	2	3	4	V
$I_{GSS}$	Gate Leakage Current	$V_{GS}=\pm 20V, V_{DS}=0V$			$\pm 100$	nA
$R_{DS(ON)}$ ⑤	Drain-Source On-state Resistance	$V_{GS}=10V, I_{DS}=20A$		5	6	m $\Omega$
		$V_{GS}=6V, I_{DS}=10A$		6.8	9	m $\Omega$
<b>Diode Characteristics</b>						
$V_{SD}$ ⑤	Diode Forward Voltage	$I_{SD}=20A, V_{GS}=0V$		0.84	1.2	V
$t_{rr}$	Reverse Recovery Time	$I_{SD}=20A, dI_{SD}/dt=100A/\mu s$		31		ns
$Q_{rr}$	Reverse Recovery Charge			44		nC
<b>Dynamic Characteristics</b> ⑥						
$R_G$	Gate Resistance	$V_{GS}=0V, V_{DS}=0V, F=1MHz$		1.7		$\Omega$
$C_{iss}$	Input Capacitance	$V_{GS}=0V,$ $V_{DS}=40V,$ Frequency=200KHz		2540		pF
$C_{oss}$	Output Capacitance			540		
$C_{riss}$	Reverse Transfer Capacitance			25		
$t_{d(ON)}$	Turn-on Delay Time	$V_{DD}=40V, I_{DS}=20A,$ $V_{GS}=10V, R_G=3\Omega$		10		ns
$t_r$	Turn-on Rise Time			46		
$t_{d(OFF)}$	Turn-off Delay Time			23		
$t_f$	Turn-off Fall Time			11		
<b>Gate Charge Characteristics</b> ⑥						
$Q_g$	Total Gate Charge	$V_{DS}=40V, V_{GS}=10V,$ $I_{DS}=20A$		40		nC
$Q_{gs}$	Gate-Source Charge			11		
$Q_{gd}$	Gate-Drain Charge			9.4		

**Notes:**

- ①Pulse width limited by safe operating area.
- ②Calculated continuous current based on maximum allowable junction temperature. The package limitation current is 50A.
- ③When mounted on 1 inch square copper board,  $t \leq 10\text{sec}$ .
- ④Limited by  $T_{Jmax}$ , Starting  $T_J = 25^\circ\text{C}$ ,  $I_{ASmax} = 42\text{A}$ ,  $L = 0.5\text{mH}$ ,  $V_{DD} = 48\text{V}$ ,  $R_G = 25\Omega$ ,  $V_{GS} = 10\text{V}$ . Part not recommended for use above this value. 100% Final Test at  $I_{AS} = 21\text{A}$ ,  $L = 0.5\text{mH}$ .
- ⑤Pulse test; Pulse width  $\leq 300\mu\text{s}$ , duty cycle  $\leq 2\%$ .
- ⑥Guaranteed by design, not subject to production testing.

**Ordering and Marking Information**

Device	Package	Packaging	Quantity	Reel Size	Tape width
KS92034NBT	PDFN5060	Tape&Reel	5000	13"	12mm



1st Line: Kwansemi LOGO, Kwansemi Code(KS)

2nd Line: Part Number(92034T)

3rd Line: Lot Number(YWWXXX)

Typical Characteristics

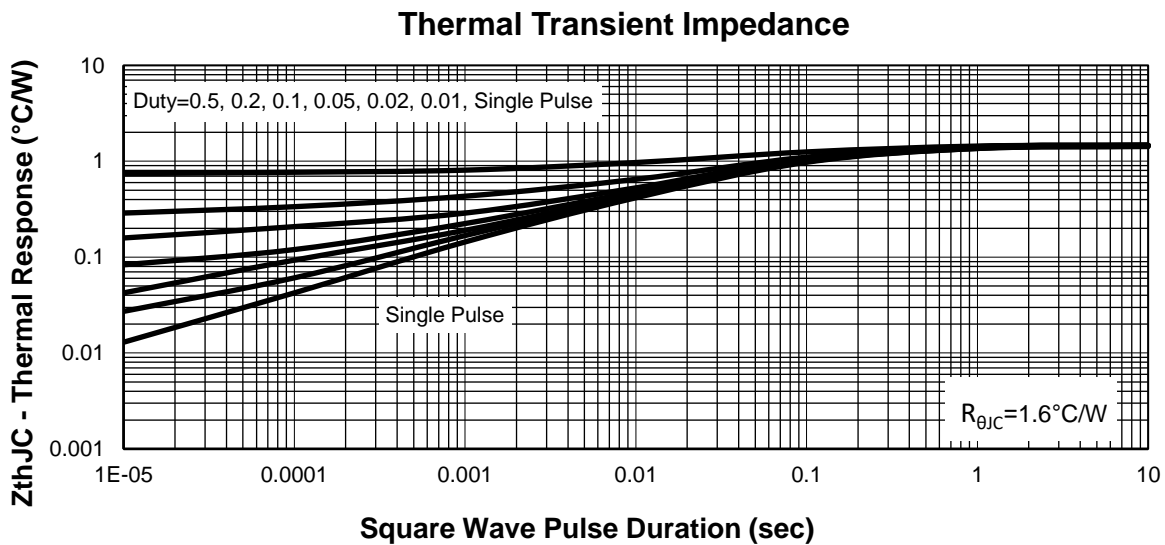
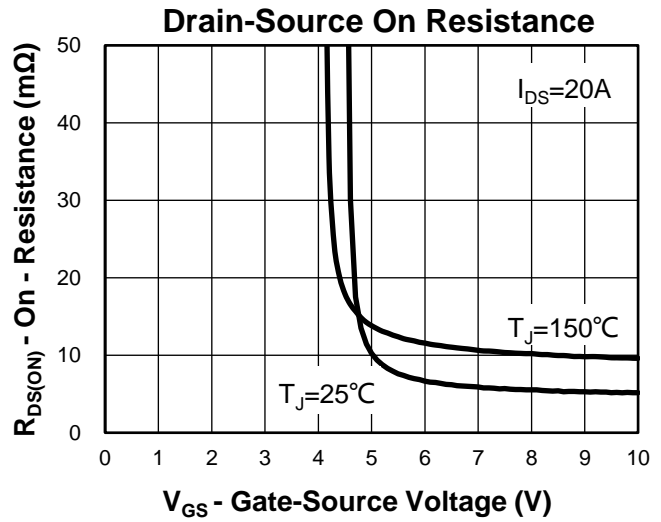
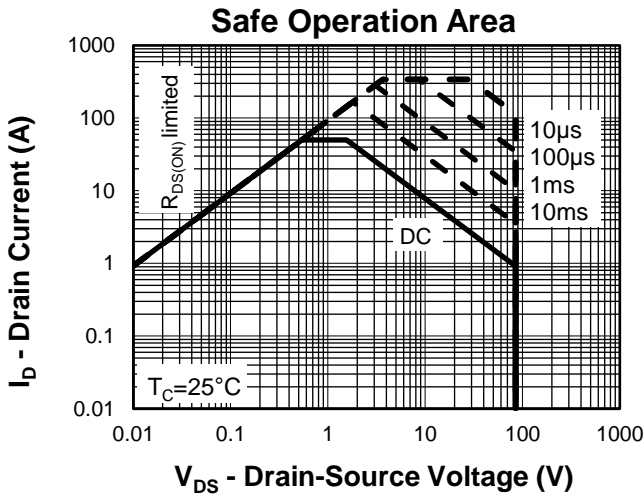
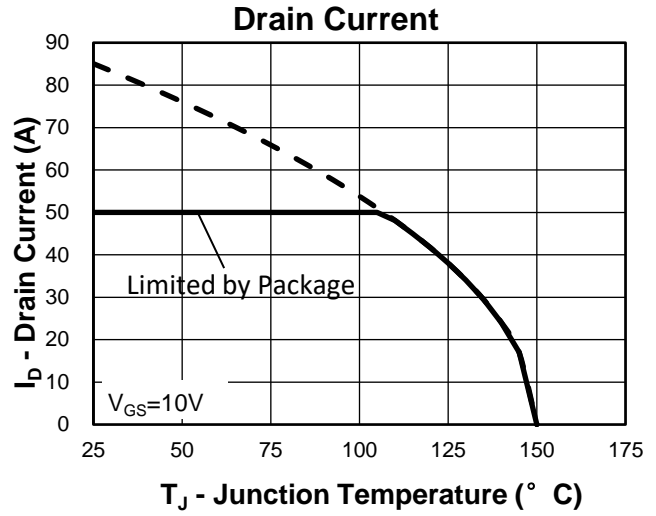
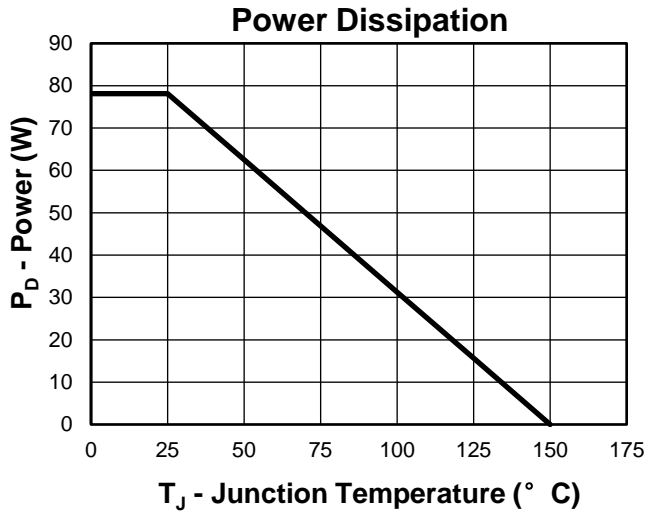

Typical Characteristics

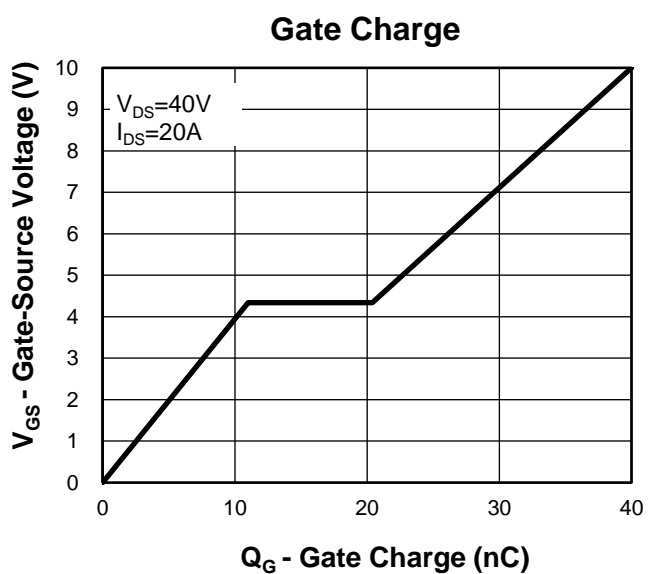
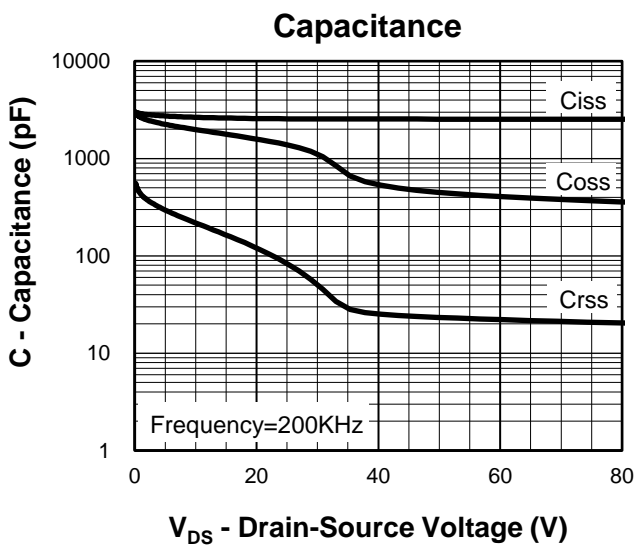
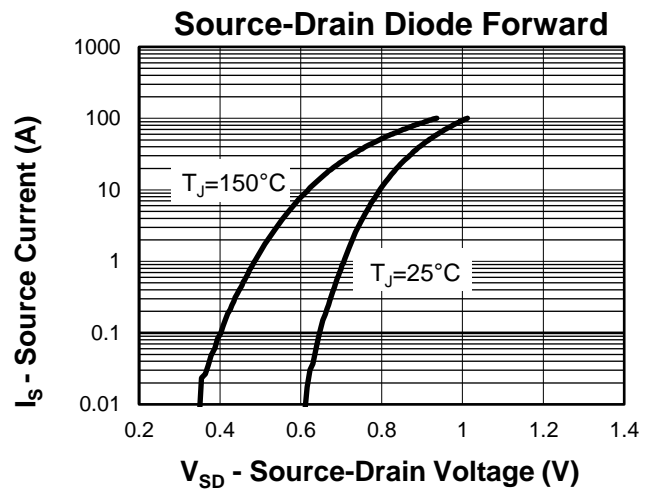
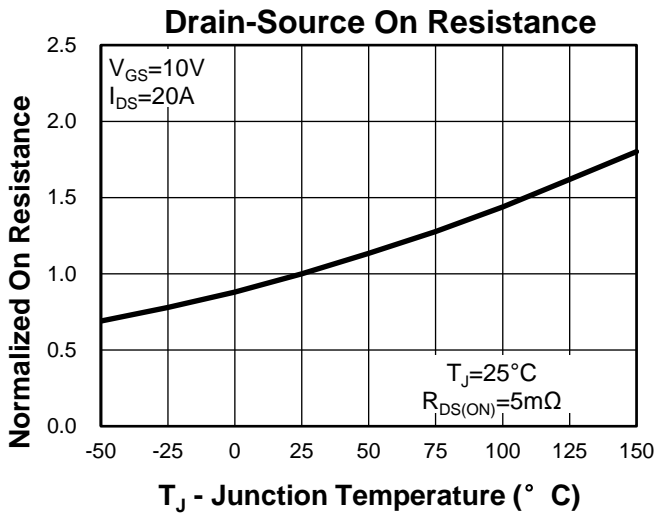
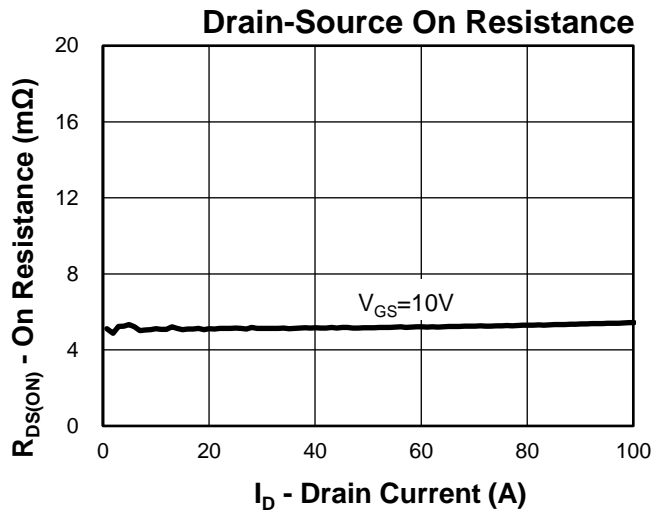
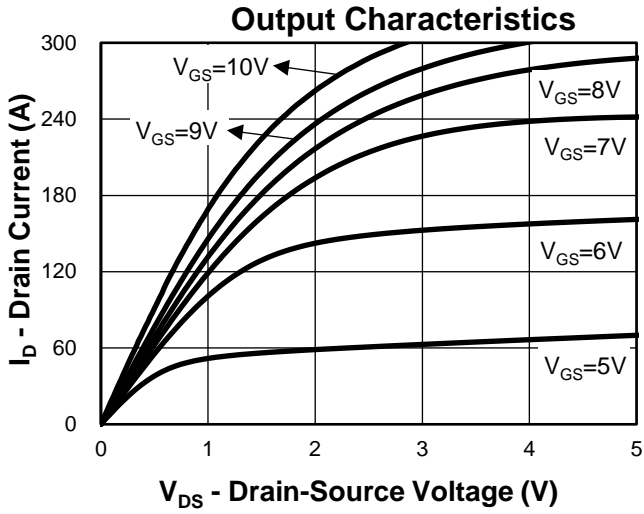

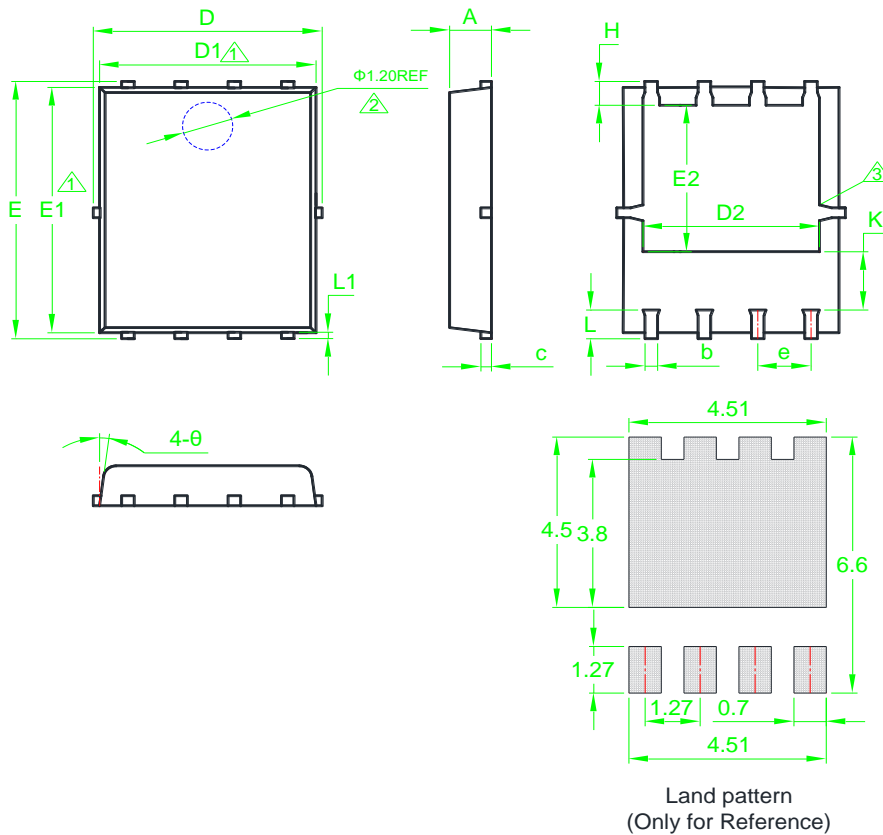
**Package Information**
**PDFN5060**

SYMBOL	MM			INCH			SYMBOL	MM			INCH		
	MIN	NOM	MAX	MIN	NOM	MAX		MIN	NOM	MAX	MIN	NOM	MAX
A	0.90	1.00	1.20	0.035	0.039	0.047	E2	3.27	3.50	3.90	0.129	0.138	0.154
b	0.25	*	0.50	0.010	*	0.020	e	1.27BSC			0.050BSC		
c	0.20	0.25	0.30	0.008	0.010	0.012	H	0.41	0.51	0.71	0.016	0.020	0.028
D	5.15BSC			0.203BSC			K	1.10	1.35	1.50	0.043	0.053	0.059
D1	4.80	5.00	5.40	0.189	0.197	0.213	L	0.51	0.61	0.71	0.020	0.024	0.028
D2	3.60	*	4.40	0.142	*	0.173	L1	0.06	0.13	0.30	0.002	0.005	0.012
E	5.90	6.15	6.30	0.232	0.242	0.248	θ	0°	*	12°	0°	*	12°
E1	5.40	5.80	5.95	0.213	0.228	0.234							

① Dimensions D1 and E1 do not include mold flash protrusions or gate burrs.

② The existence and size of demolding hole are variable depending on mold.

③ The size and shape of exposed pad are variable depending on mold.

### Avalanche Test Circuit and Waveforms



### Switching Time Test Circuit and Waveforms



### Diode Recovery Test Circuit and Waveforms



### Gate Charge Test Circuit and Waveform



### Customer Service

Kwansemi Semiconductor Co.,Ltd

Email:Sales@kwansemi.com

Web:www.kwansemi.com

### DISCLAIMER:

Kwansemi reserves the right to change the specifications and circuitry without notice at any time. The Products are not designed for use in hostile environments, including, without limitation, aircraft, nuclear power generation, medical appliances, and devices or systems in which malfunction of any Product can reasonably be expected to result in a personal injury. Seller's customers using or selling Seller's products for use in such applications do so at their own risk and agree to fully defend and indemnify Seller.