

Features

- 85V/107A,
 $R_{DS(ON)} = 4m\Omega(Typ.)@V_{GS}=10V$
- Excellent $Q_G \times R_{DS(on)}$ product(FOM)
- SGT Technology
- 100% avalanche tested

Applications

- Switching Application Systems
- DC/DC Converter



Pin Description

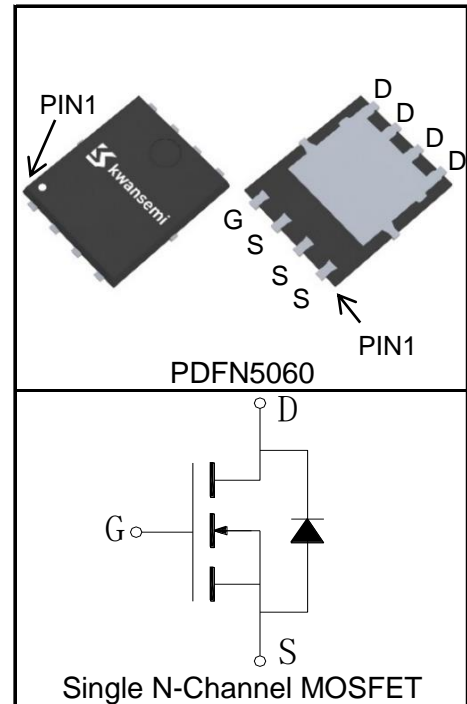

Absolute Maximum Ratings

Symbol	Parameter	Rating	Unit	
Common Ratings ($T_C=25^\circ C$ Unless Otherwise Noted)				
V_{DSS}	Drain-Source Voltage	85	V	
V_{GSS}	Gate-Source Voltage	± 20	V	
T_{Jmax}	Maximum Junction Temperature	150	$^\circ C$	
T_J, T_{STG}	Operating and Storage Temperature Range	-55 to 150	$^\circ C$	
I_S	Diode Continuous Forward Current	$T_C=25^\circ C$	107	A
Mounted on Large Heat Sink				
$I_{DP}^{①}$	Pulse Drain Current	$T_C=25^\circ C$	428	A
$I_D^{②}$	Continuous Drain Current@ $T_C(V_{GS}=10V)$	$T_C=25^\circ C$	107	A
		$T_C=100^\circ C$	67	
	Continuous Drain Current@ $T_A(V_{GS}=10V)^{③}$	$T_A=25^\circ C$	22	
		$T_A=70^\circ C$	17	
P_D	Maximum Power Dissipation@ T_C	$T_C=25^\circ C$	96	W
		$T_C=100^\circ C$	38	
	Maximum Power Dissipation@ $T_A^{③}$	$T_A=25^\circ C$	4.2	
		$T_A=70^\circ C$	2.7	

Symbol	Parameter	Rating	Unit
$R_{\theta JC}$	Thermal Resistance-Junction to Case	1.3	°C/W
$R_{\theta JA}$ ③	Thermal Resistance-Junction to Ambient	30	°C/W
Drain-Source Avalanche Ratings			
E_{AS} ④	Avalanche Energy, Single Pulsed	506	mJ

Electrical Characteristics ($T_C=25^\circ\text{C}$ Unless Otherwise Noted)

Symbol	Parameter	Test Condition	KS92028NAT			Unit
			Min.	Typ.	Max.	
Static Characteristics						
BV_{DSS}	Drain-Source Breakdown Voltage	$V_{GS}=0V, I_{DS}=250\mu A$	85			V
I_{DSS}	Zero Gate Voltage Drain Current	$V_{DS}=85V, V_{GS}=0V$			1	μA
		$T_J=125^\circ\text{C}$			30	
$V_{GS(th)}$	Gate Threshold Voltage	$V_{DS}=V_{GS}, I_{DS}=250\mu A$	2	3	4	V
I_{GSS}	Gate Leakage Current	$V_{GS}=\pm 20V, V_{DS}=0V$			± 100	nA
$R_{DS(ON)}$ ⑤	Drain-Source On-state Resistance	$V_{GS}=10V, I_{DS}=20A$		4	4.8	$m\Omega$
		$V_{GS}=6V, I_{DS}=10A$		5.5	7.2	$m\Omega$
Diode Characteristics						
V_{SD} ⑤	Diode Forward Voltage	$I_{SD}=20A, V_{GS}=0V$		0.81	1.2	V
t_{rr}	Reverse Recovery Time	$I_{SD}=20A, dI_{SD}/dt=100A/\mu s$		36		ns
Q_{rr}	Reverse Recovery Charge			61		nC
Dynamic Characteristics ⑥						
R_G	Gate Resistance	$V_{GS}=0V, V_{DS}=0V, F=200\text{KHz}$		1.6		Ω
C_{iss}	Input Capacitance	$V_{GS}=0V,$ $V_{DS}=40V,$ Frequency=200KHz		3045		pF
C_{oss}	Output Capacitance			850		
C_{riss}	Reverse Transfer Capacitance			35		
$t_{d(ON)}$	Turn-on Delay Time	$V_{DD}=40V, I_{DS}=20A,$ $V_{GS}=10V, R_G=3\Omega$		12		ns
t_r	Turn-on Rise Time			44		
$t_{d(OFF)}$	Turn-off Delay Time			27		
t_f	Turn-off Fall Time			15		
Gate Charge Characteristics ⑥						
Q_g	Total Gate Charge	$V_{DS}=40V, V_{GS}=10V,$ $I_{DS}=20A$		46		nC
Q_{gs}	Gate-Source Charge			13		
Q_{gd}	Gate-Drain Charge			11		

Notes:

- ①Pulse width limited by safe operating area.
- ②Calculated continuous current based on maximum allowable junction temperature. The package limitation current is 50A.
- ③When mounted on 1 inch square copper board, $t \leq 10\text{sec}$.
- ④Limited by $T_{J\text{max}}$, Starting $T_J = 25^\circ\text{C}$, $I_{AS\text{max}} = 45\text{A}$, $L = 0.5\text{mH}$, $V_{DD} = 48\text{V}$, $R_G = 25\Omega$, $V_{GS} = 10\text{V}$. Part not recommended for use above this value. 100% Final Test at $I_{AS} = 23\text{A}$, $L = 0.5\text{mH}$.
- ⑤Pulse test; Pulse width $\leq 300\mu\text{s}$, duty cycle $\leq 2\%$.
- ⑥Guaranteed by design, not subject to production testing.

Ordering and Marking Information

Device	Package	Packaging	Quantity	Reel Size	Tape width
KS92028NAT	PDFN5060	Tape&Reel	5000	13"	12mm



1st Line: Kwansemi LOGO, Kwansemi Code(KS)

2nd Line: Part Number(92028T)

3rd Line: Lot Number(YWWXXX)

Typical Characteristics

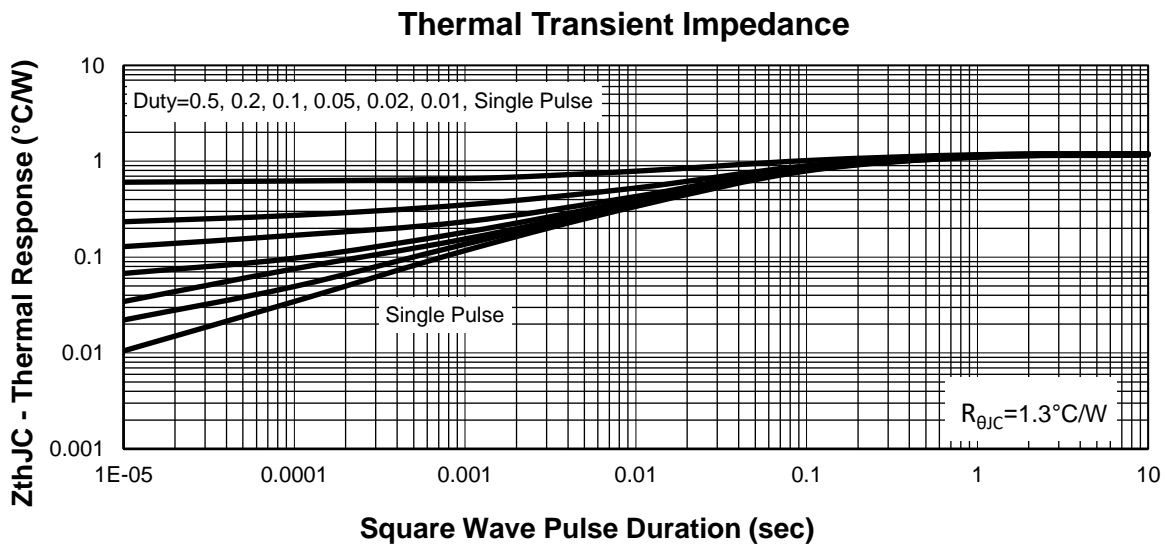
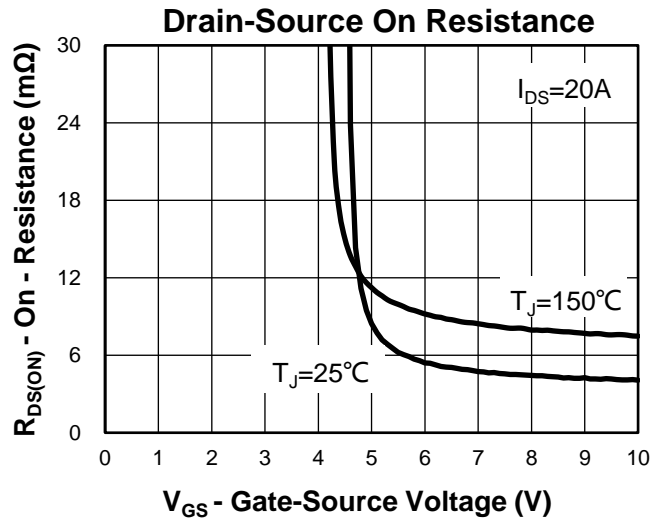
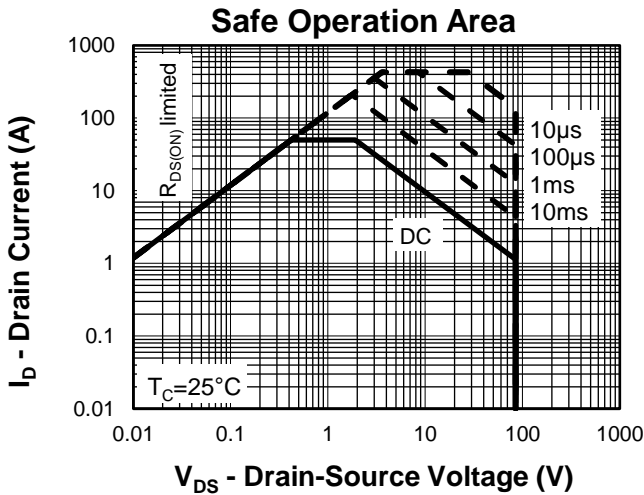
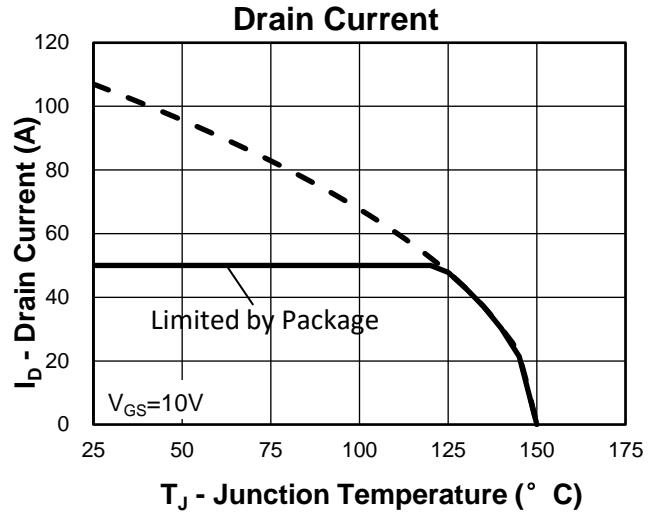
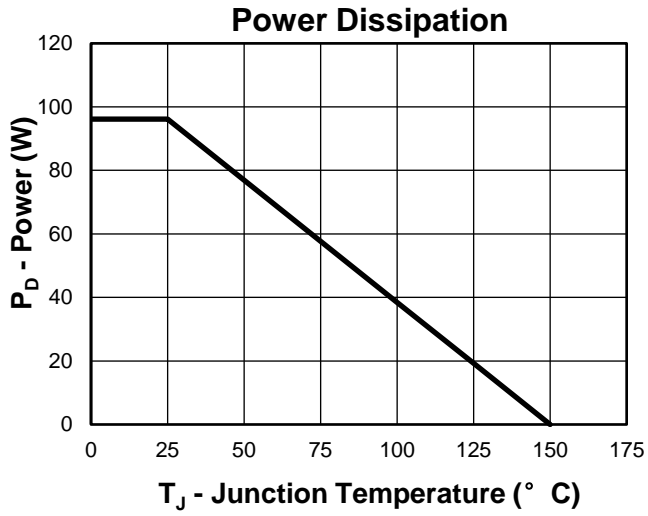

Typical Characteristics

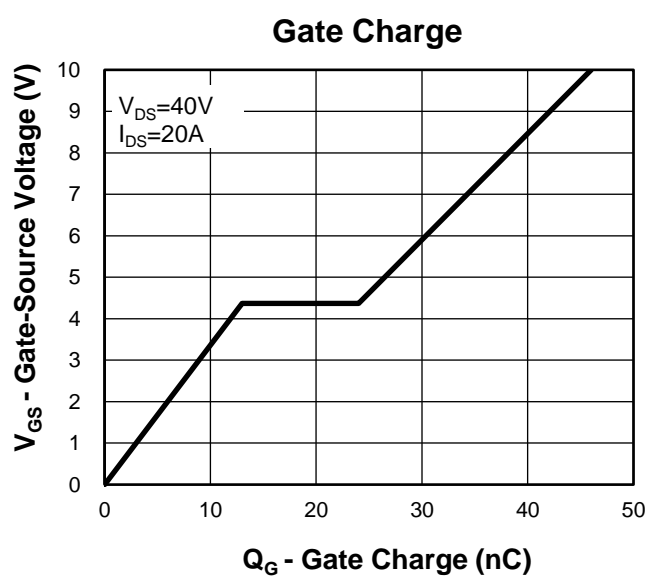
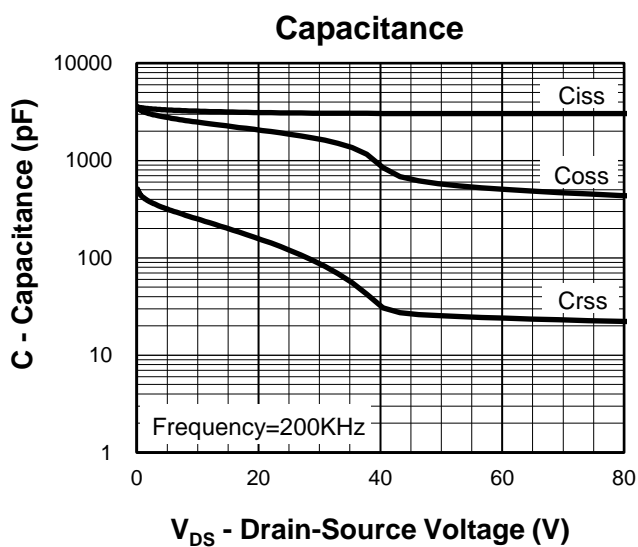
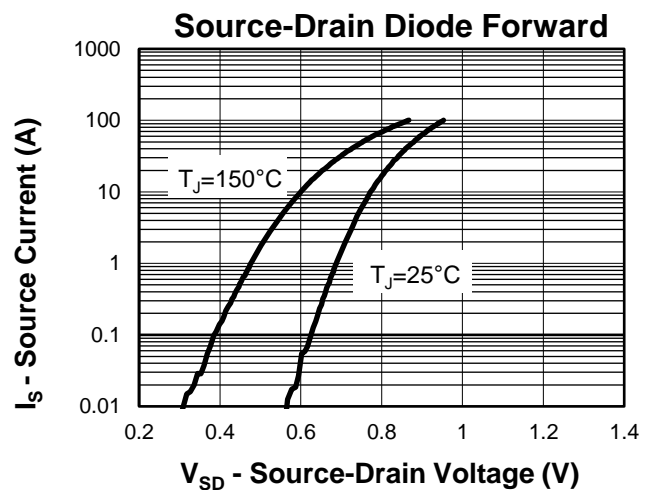
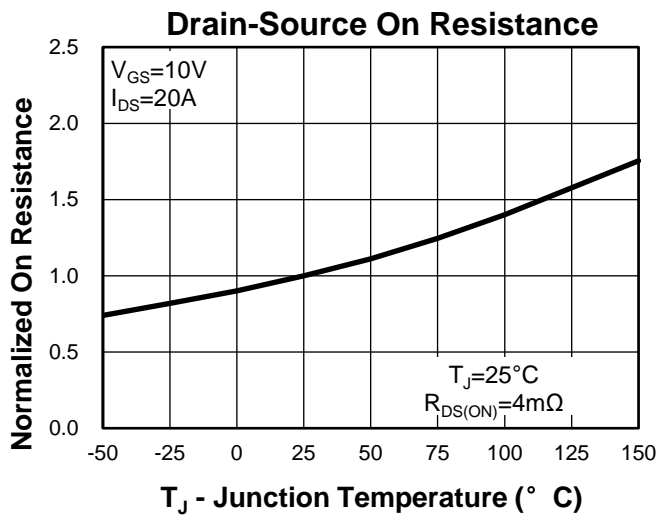
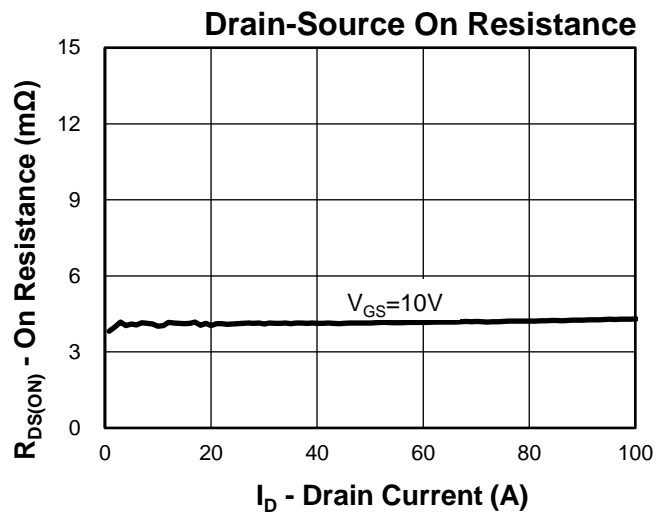
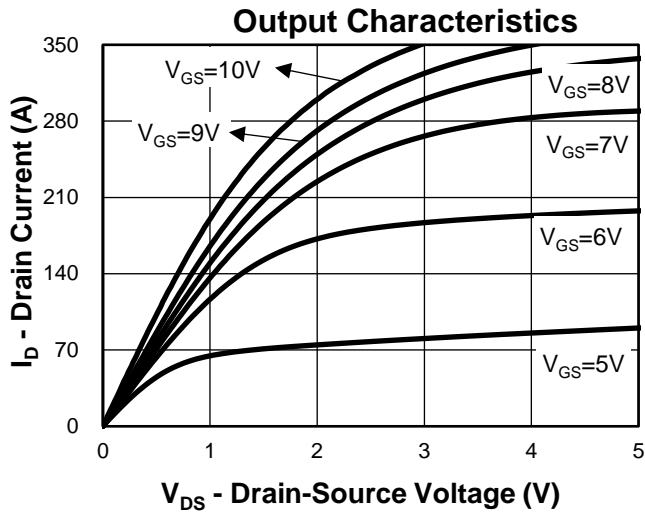

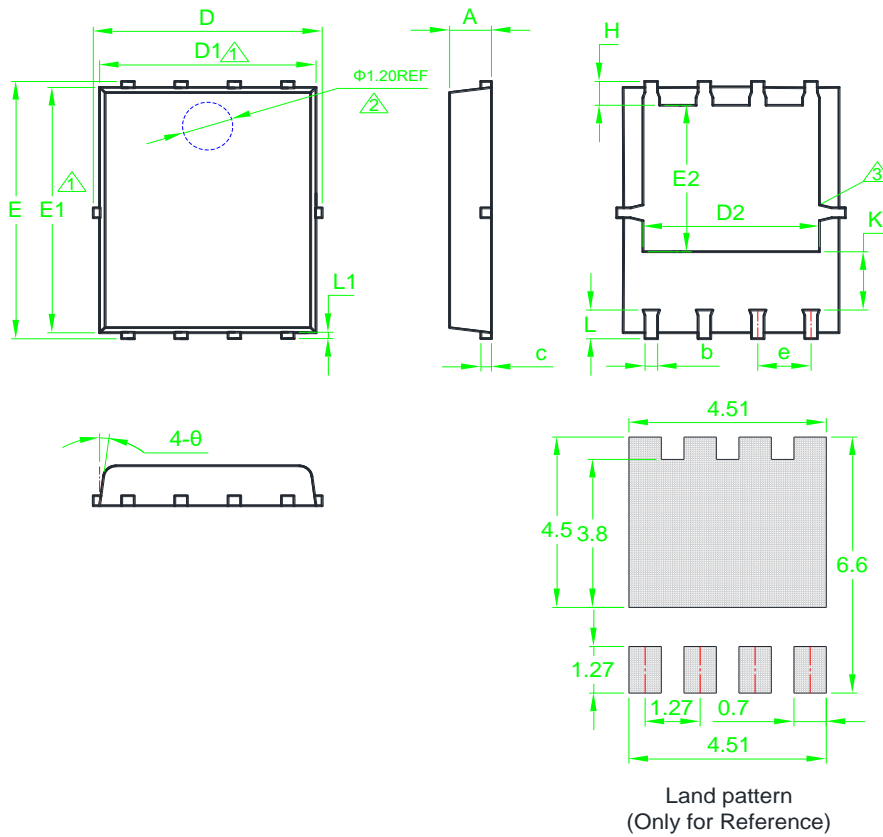
Package Information
PDFN5060

SYMBOL	MM			INCH			SYMBOL	MM			INCH		
	MIN	NOM	MAX	MIN	NOM	MAX		MIN	NOM	MAX	MIN	NOM	MAX
A	0.90	1.00	1.20	0.035	0.039	0.047	E2	3.27	3.50	3.90	0.129	0.138	0.154
b	0.25	*	0.50	0.010	*	0.020	e	1.27BSC			0.050BSC		
c	0.20	0.25	0.30	0.008	0.010	0.012	H	0.41	0.51	0.71	0.016	0.020	0.028
D	5.15BSC			0.203BSC			K	1.10	1.35	1.50	0.043	0.053	0.059
D1	4.80	5.00	5.40	0.189	0.197	0.213	L	0.51	0.61	0.71	0.020	0.024	0.028
D2	3.60	*	4.40	0.142	*	0.173	L1	0.06	0.13	0.30	0.002	0.005	0.012
E	5.90	6.15	6.30	0.232	0.242	0.248	θ	0°	*	12°	0°	*	12°
E1	5.40	5.80	5.95	0.213	0.228	0.234							

- ① Dimensions D1 and E1 do not include mold flash protrusions or gate burrs.
- ② The existence and size of demolding hole are variable depending on mold.
- ③ The size and shape of exposed pad are variable depending on mold.

Avalanche Test Circuit and Waveforms



Switching Time Test Circuit and Waveforms



Diode Recovery Test Circuit and Waveforms



Gate Charge Test Circuit and Waveform



Customer Service

Kwansemi Semiconductor Co.,Ltd

Email:Sales@kwansemi.com

Web:www.kwansemi.com

DISCLAIMER:

Kwansemi reserves the right to change the specifications and circuitry without notice at any time. The Products are not designed for use in hostile environments, including, without limitation, aircraft, nuclear power generation, medical appliances, and devices or systems in which malfunction of any Product can reasonably be expected to result in a personal injury. Seller's customers using or selling Seller's products for use in such applications do so at their own risk and agree to fully defend and indemnify Seller.